

For Husqvarna Parts Call 606-678-9623 or 606-561-4983

Husqvarna



42, 42D, 242

Workshop Manual

531 03 01-21

www.mymowerparts.com

Introduction

The procedures included in this workshop manual are designed to provide you, the technician, with the necessary information for repair and service of models 42, 42D and 242 chain saws.

The information, specifications and illustrations in this publication are based on the information in effect at time of printing. Continued product improvement may result in changes to these saws that may not be included in this manual. Later editions are revised to include any product changes that may have occurred.

Safety Statements

The following safety statements are found throughout this manual and are designed to make you aware of potential hazards or unsafe practices.

- WARNING -

Immediate hazards which can result in severe injury or death.



CAUTION: Hazards or unsafe practices which can result in severe personal injury.

IMPORTANT: Hazards or unsafe practices which can result in product or property damage.

NOTE: Additional pertinent information.

Table of Contents

Page No.		Section
2	Technical Specifications	1
3	Service Tools	2
4	Safety Equipment	3
11	Starter	4
16	Ignition System	5
23	Heated Handles	6
25	Centrifugal Clutch	7
29	Chain Lubrication System	8
33	Anti-Vibration System	9
34	Fuel System	10
44	Cylinder and Piston	11
48	Crankcase and Crankshaft	12
54	Troubleshooting	13

Engine

Displacement	-----	42.0 cc (2.5 cu. in.)
Bore	-----	42.0 mm
Stroke	-----	30.0 mm
Maximum No Load RPM		
Model 242	-----	15500rpm
Model 42(D)	-----	13000 rpm
Idling Speed	-----	2900 rpm
Clutch Engagement Speed	-----	3900 rpm

Fuel and Chain Lubrication System

Carburetor	-----	Walbro HDA 34
Fuel Tank Volume	-----	0.5 litres (1.1 pints)
Oil Pump Capacity	-----	3-7 cc/rein at 9000 rpm
Oil Tank Volume	-----	0.27 litres (0.55 pints)

Ignition System

Ignition System	-----	SEM AM7
Air Gap	-----	0.3 mm (.012 inch)
Spark Plug	-----	NGK-BPMR6A CHAMPION-RCJ7Y
Electrode Gap	-----	0.5 mm (.02 inch)

Heated Handles

Model 242	-----	65 watts at 10000 rpm
Model 42(D)	-----	NA

Bar and Chain

Bar Length Minto Max	-----	13-18 inches (33 -46 cm)
Drive Sprocket	-----	7 tooth
Chain Speed		
Model 242	-----	19.7 m/secat9000 rpm
Model 42(D)	-----	17.3 m/secat9000 rpm
Chain Pitch	-----	0.325 inches
Drive Link Gauge	-----	1.5 mm (.058 inches)

Weight

Model 242	-----	4.6 kg (10.1 lbs)
Model 42(D)	-----	4.5 kg (9.9 lbs)

Weight with 13 inch Guide Bar and Chain

Model 242	-----	5.3 kg (1 1.7 lbs)
Model 42(D)	-----	5.2 kg (1 1.4 lbs)

5025006-01	Assembling pliers, spark plug
5025026-01	Puller screw
5025030-07	Crankshaft installer
5025033-01	Piston stop
5025038-01	Pressure gauge
5025067-01	Wrench (11 mm)
5025070-01	Piston ring compressor
5025079-01	Seal Installer
5025082-01	Drift
5025083-01	Hook for fuel filter
5053818-17	Oil gear puller
5025134-02	Air gap gauge
5025149-01	Holding bar for flywheel puller
5025161.01	Crankcase puller
50271 13-01	Test plug
5027114-01	Tachometer

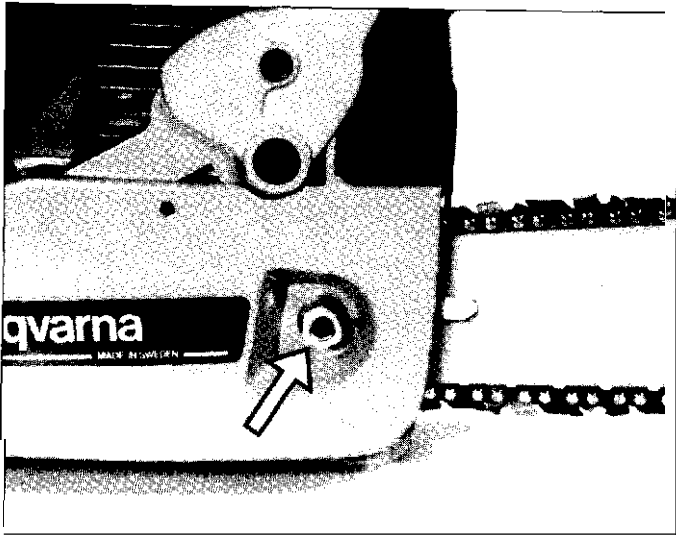

Chain Brake

Disassembly

Disengage chain brake. Remove clutch cover retaining nut and remove cover. Clean chain brake and clutch cover assembly,

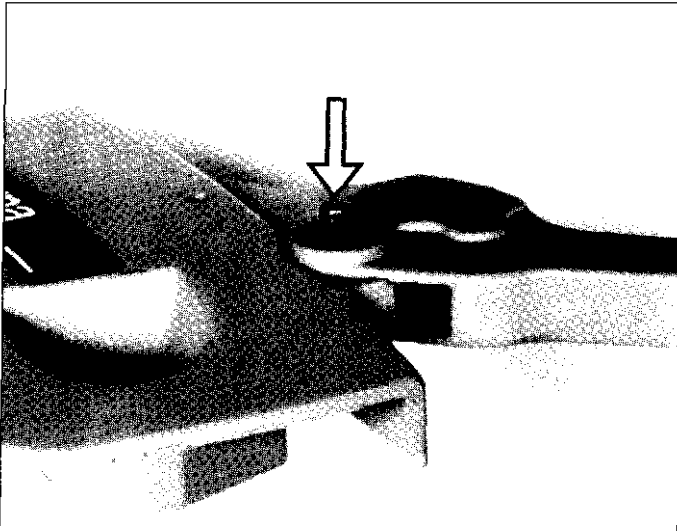

Remove hand guard retaining screw. Rethread screw into pivot sleeve two turns. Press on screw head to drive out inner pivot sleeve half.

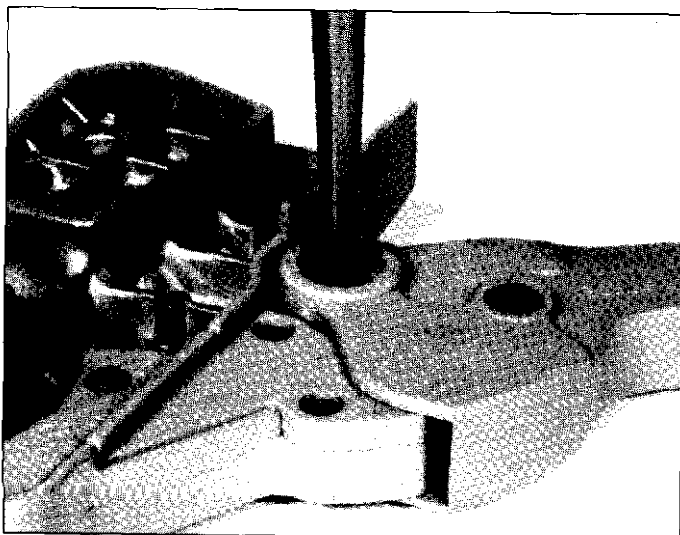

Turn cover to opposite side. Using a suitable punch, remove outer half of pivot sleeve. Separate hand guard from cover.

Remove screws (4) and cover plate.

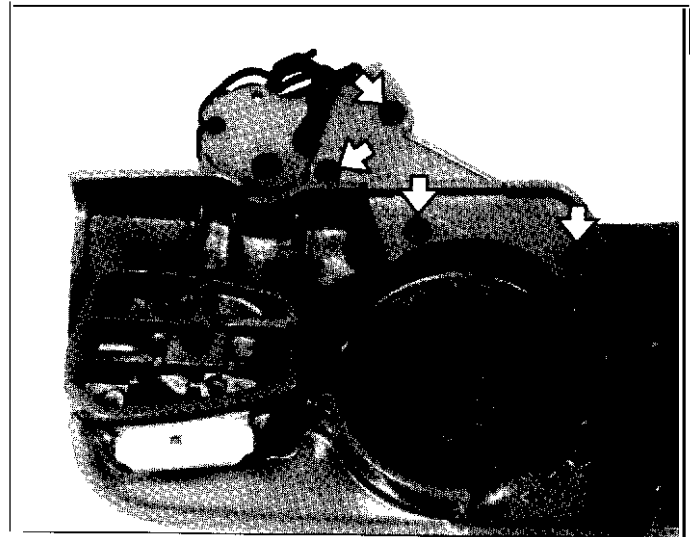

- WARNING -

Wear eye protection when removing spring to prevent injury



Using a screwdriver, pry out brake spring.

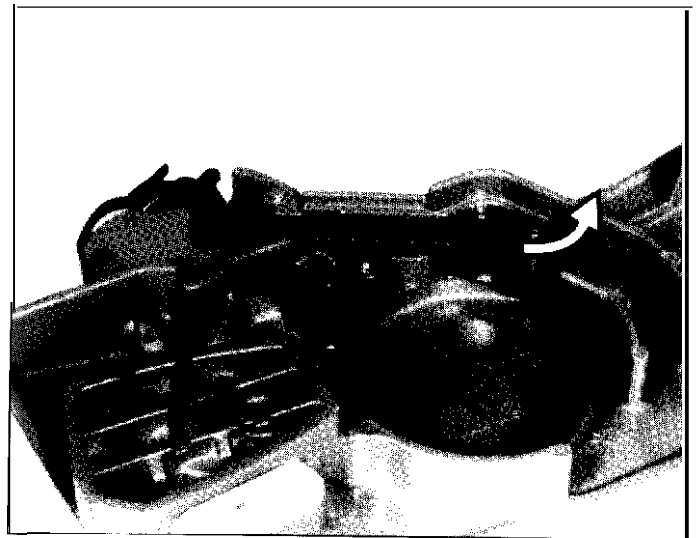

Using a punch, drive out knee link retaining pin.

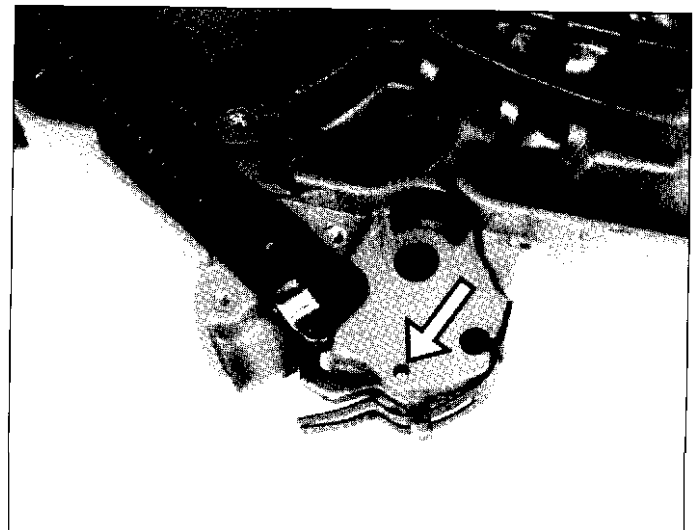

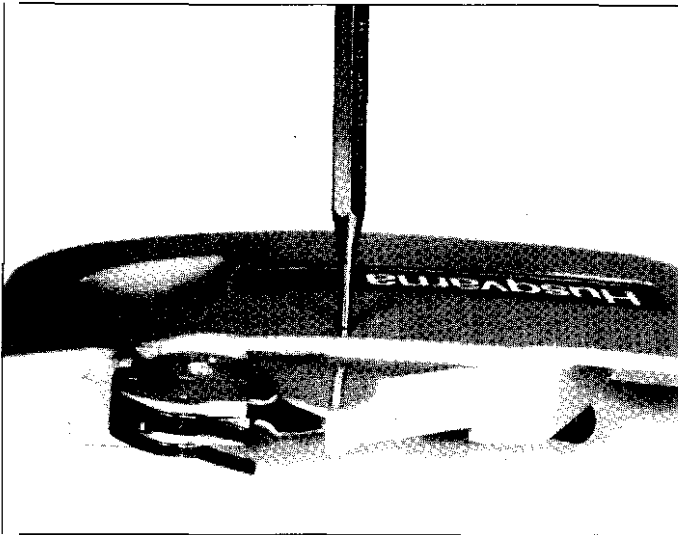

Position punch in clutch cover as shown, and drive out brake band roll pin. Remove brake band and knee link assembly.

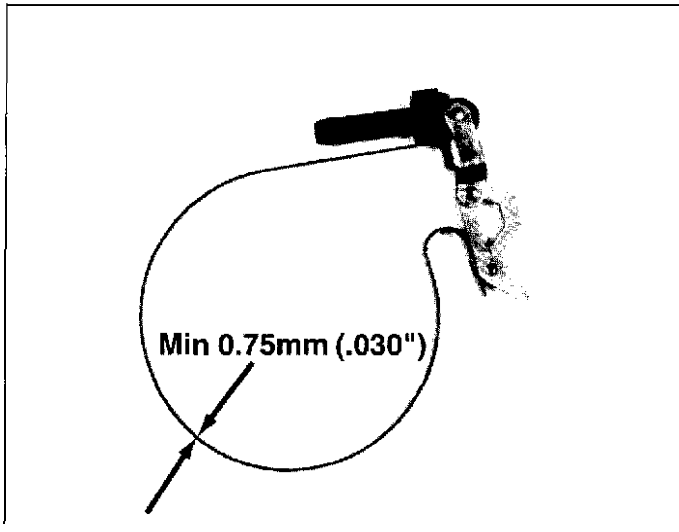

Check brake band for damage or wear. The brake band thickness should not be less than 0.75 mm (.030") when measured at any point along the band.

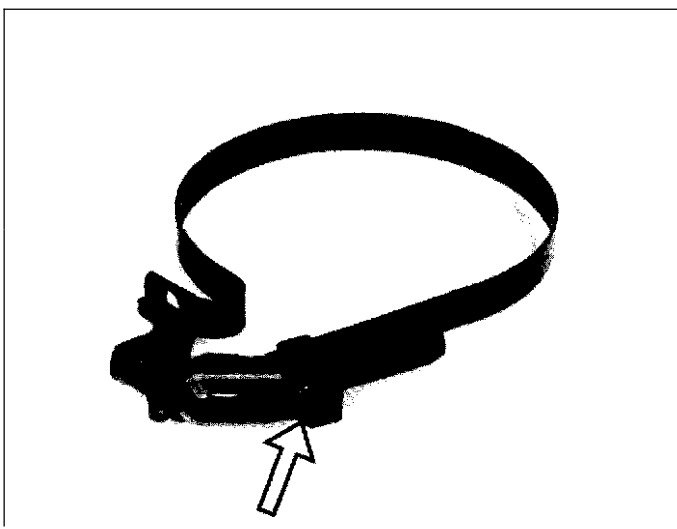

The brake band must be replaced if the band is damaged or worn less than minimum thickness. If brake band requires replacement, remove screw and replace band.

Assembly

Apply a thin coating of oil to brake mechanism parts. Position brake band and knee link in cover.

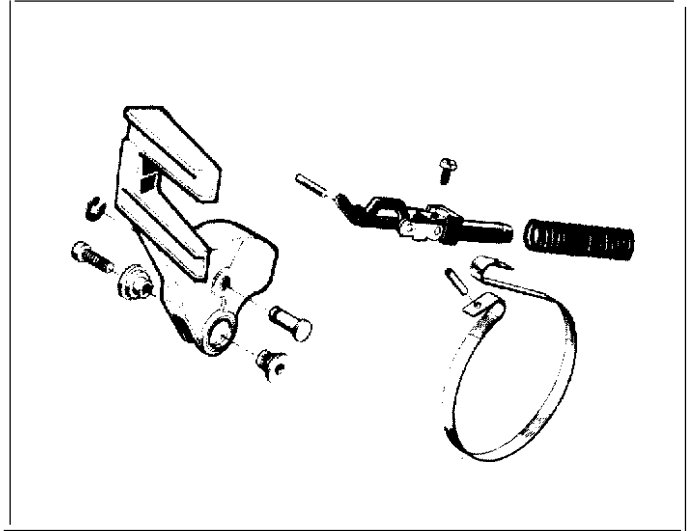

Install knee link assembly and roll pins. Install spring on knee link mechanism.

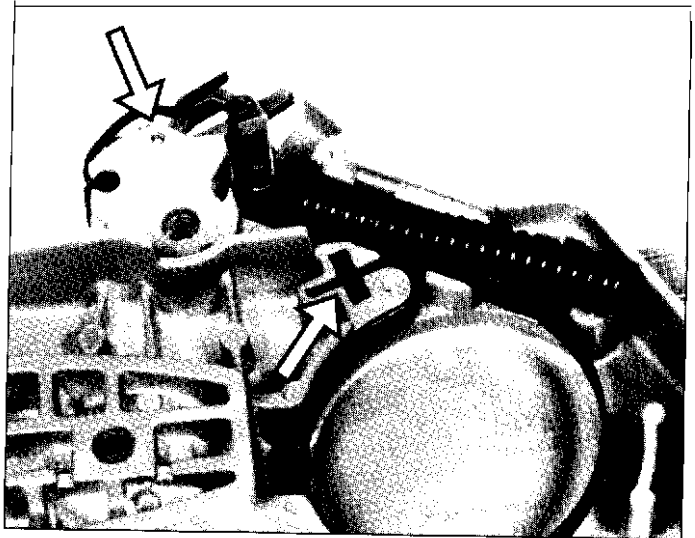

- WARNING -

Wear eye protection when installing spring to prevent injury



With screwdriver positioned as shown, press spring into place.

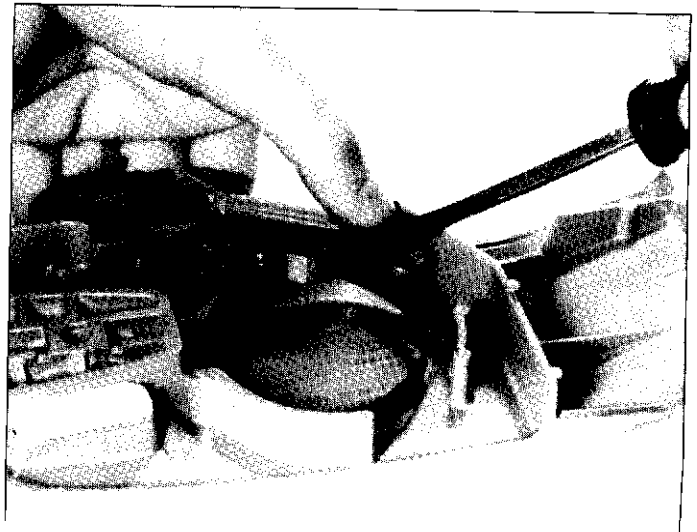

3

Safety Equipment

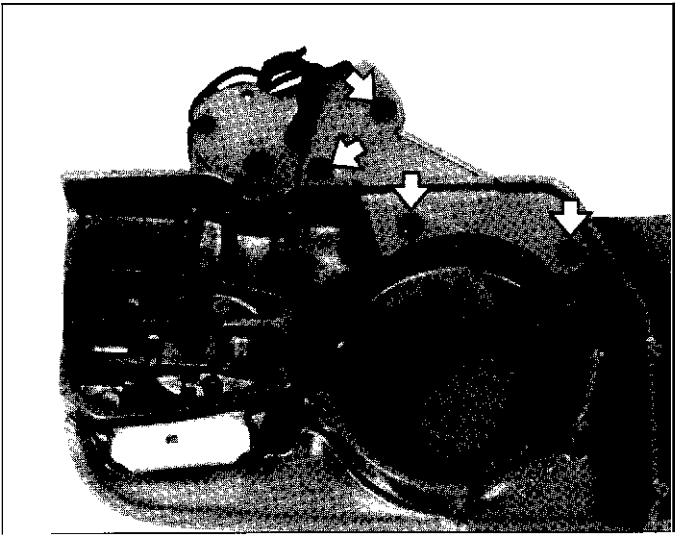

Install cover plate and secure with (4) screws.

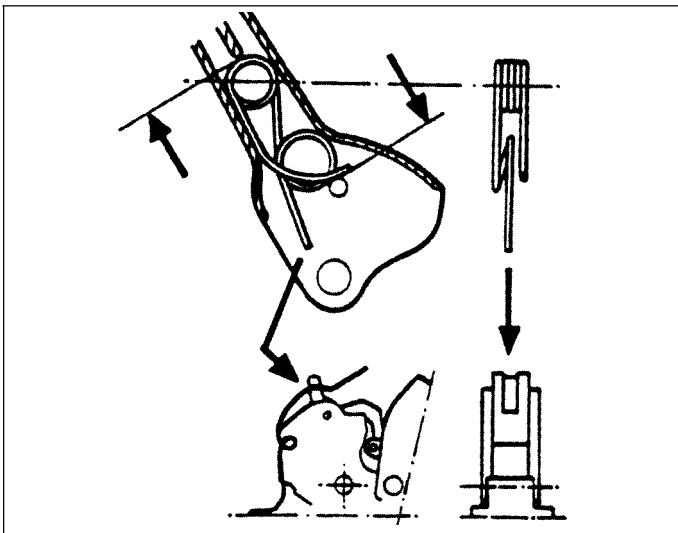

Position hand guard on clutch cover. Press pivot sleeve halves into place.

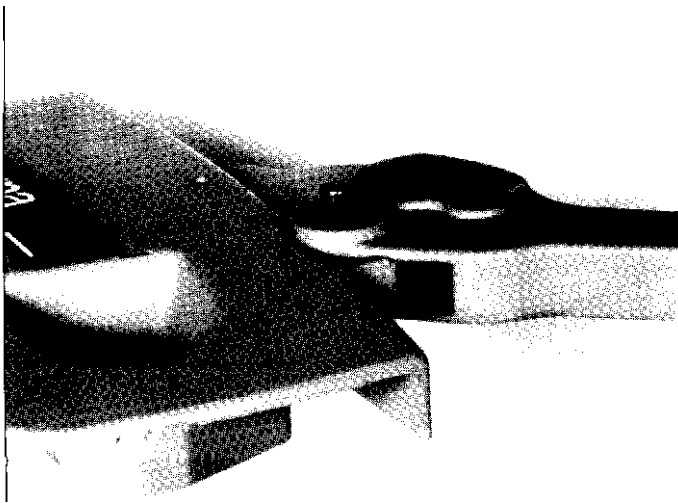

Install and tighten screw. Disengage chain brake.

Install bar, chain and clutch cover on saw. Test chain brake for proper operation.

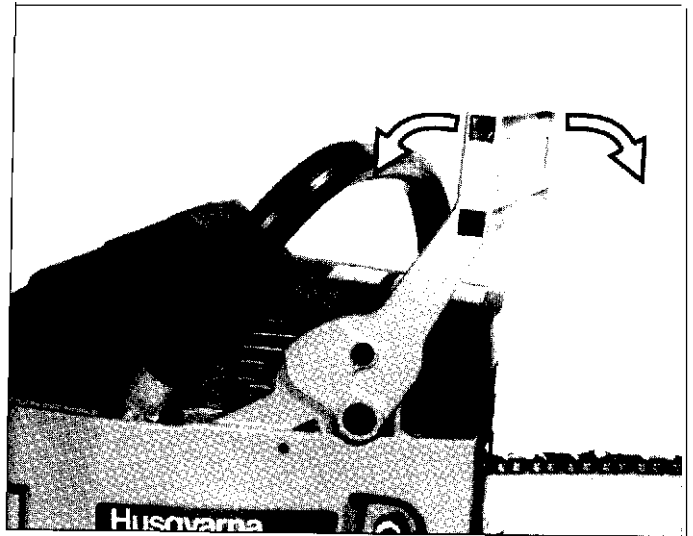

Inertia Chain Brake Engagement

- WARNING -
The engine must be shut off.



Hold the saw approximately 35 cm (14") above a stump or other firm object. Release grip on front handle and allow front of saw to drop. When the bar tip hits the object, the chain brake should activate.



Manual Chain Brake Engagement

Place the saw on firm ground and start the engine. While holding the saw with both hands, apply full throttle. Activate chain brake by turning left wrist against hand guard as shown. Chain should stop immediately.

- WARNING -
Avoid contact between any object and the guide bar tip. Contact can cause the chain and guide bar to suddenly move upward and backward toward the user. Use both hands on the handles. Follow all safety precautions in the operator's manual. Failure to follow instructions could result in serious personal injury.

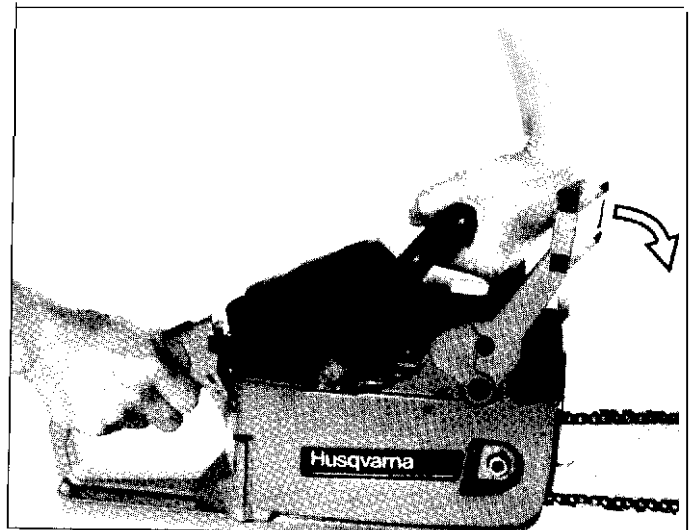

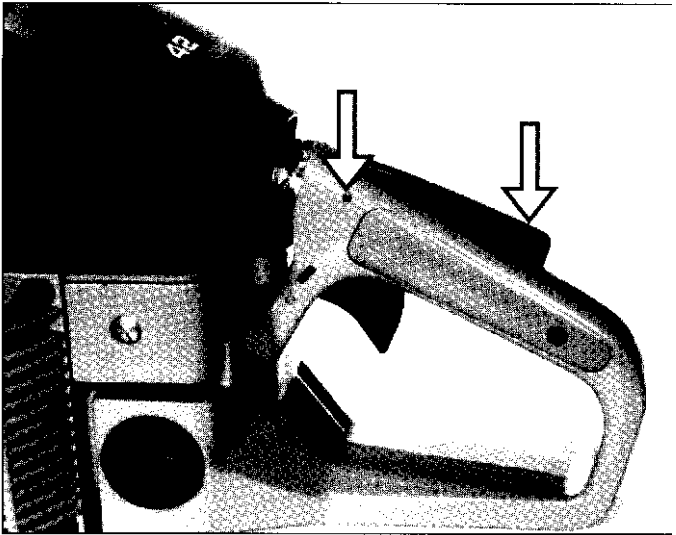

Throttle Trigger Lockout

Disassembly

Press out pin and remove throttle lockout.

Assembly

Install throttle lockout and secure with pin.

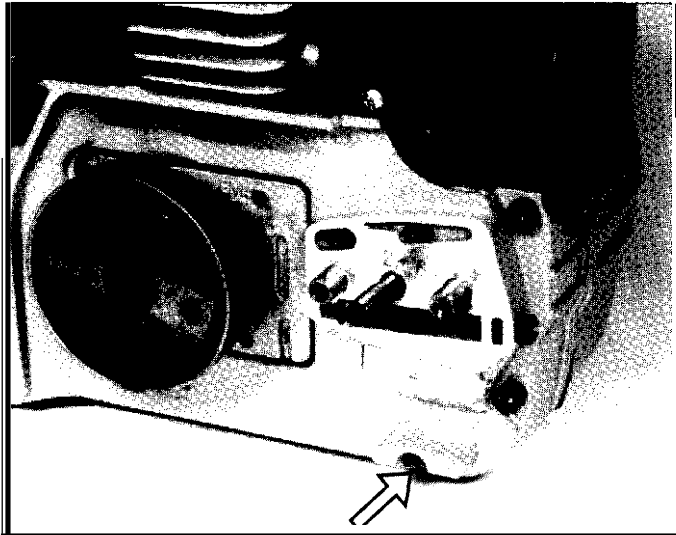

Chain Catcher

Inspect chain catcher. If damage is evident, remove screw and replace chain catcher.

Disassembly

Remove screws (4) and starter assembly.

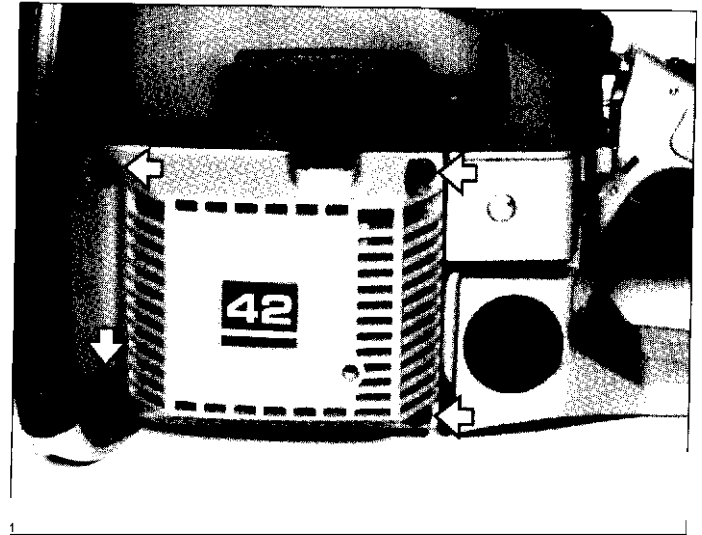

Pull starter cord out approximately 30 cm (12") and position in starter pulley recess. Carefully allow pulley to rotate counterclockwise until spring tension has been relieved.

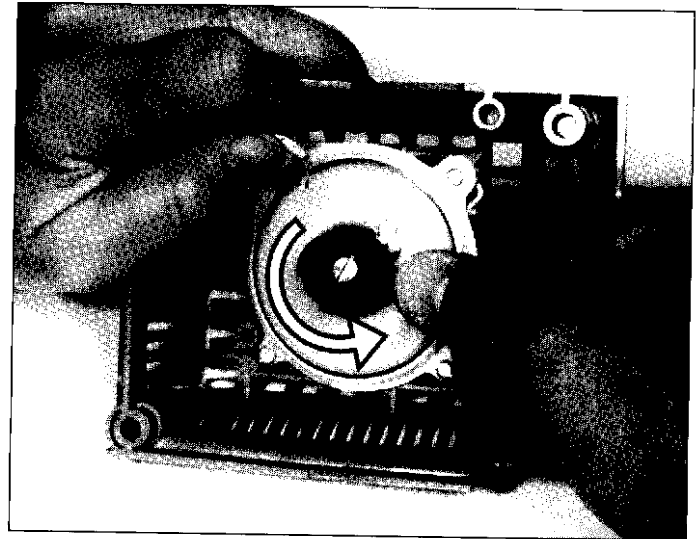

Remove screws (4) from guard ring.

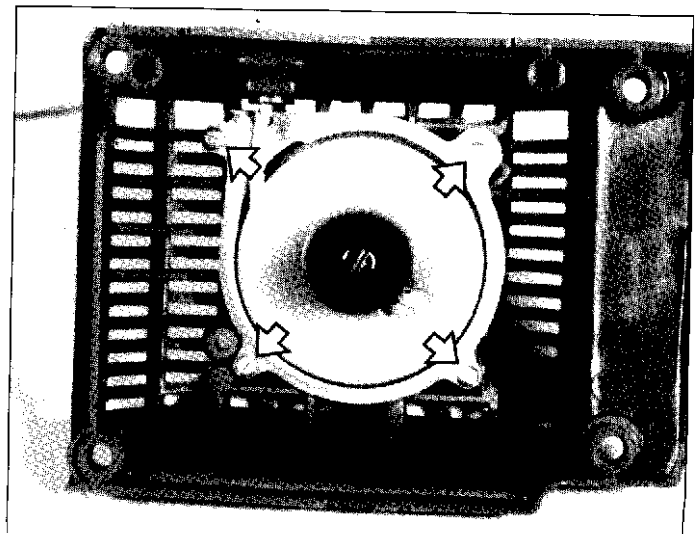

Starter

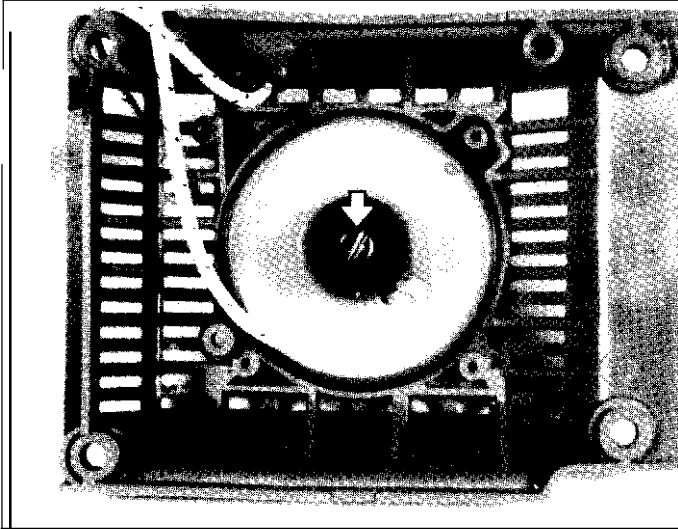

- WARNING -

Wear eye protection when removing spring to prevent injury



Remove center post screw and washer.
Carefully withdraw starter pulley.

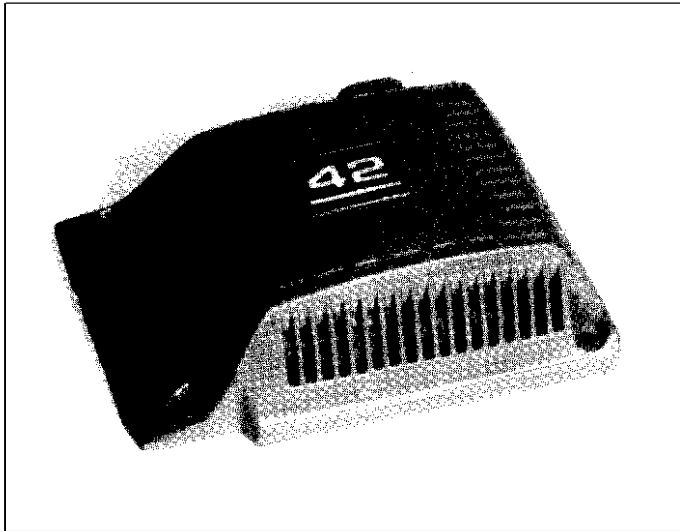

- WARNING -

Wear eye protection when removing spring to prevent injury



Position starter so spring side is toward bench.
Tap housing down on bench sharply to remove recoil spring.

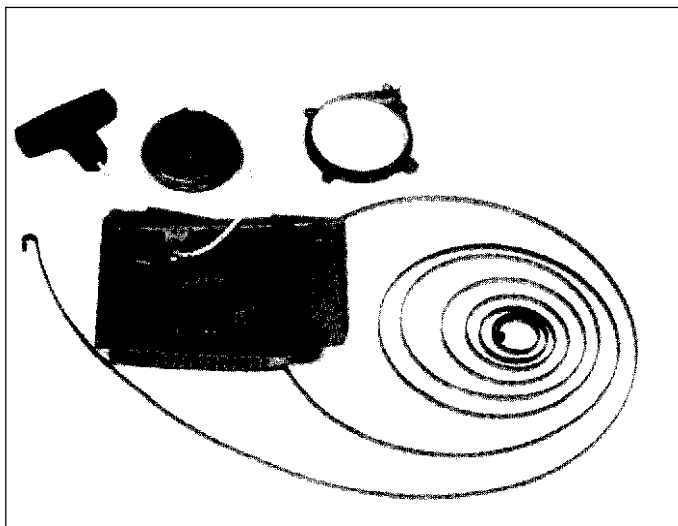

Clean all starter parts and check for wear or damage.

Assembly

- WARNING -

Wear eye protection when installing spring to prevent injury



Insert hook on outer end of recoil spring into starter housing as shown. Using thumbs, carefully install new recoil spring into place.

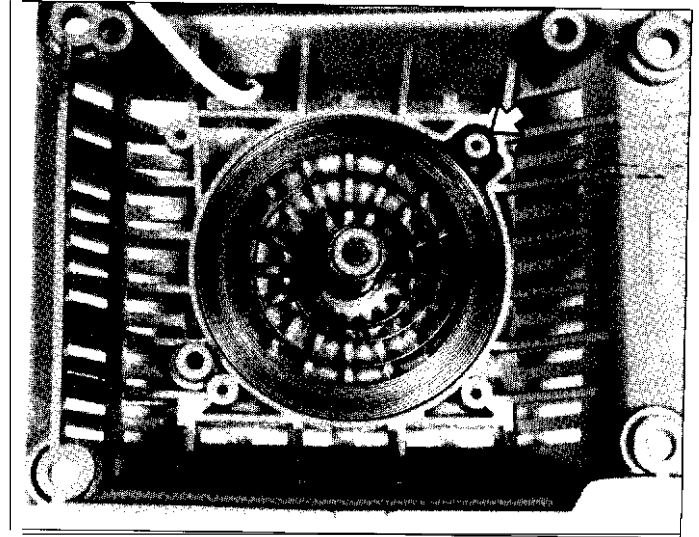

Install starter cord into pulley as shown. Melt cord end to seal knot. If knot is too large it may interfere with starter pawls.

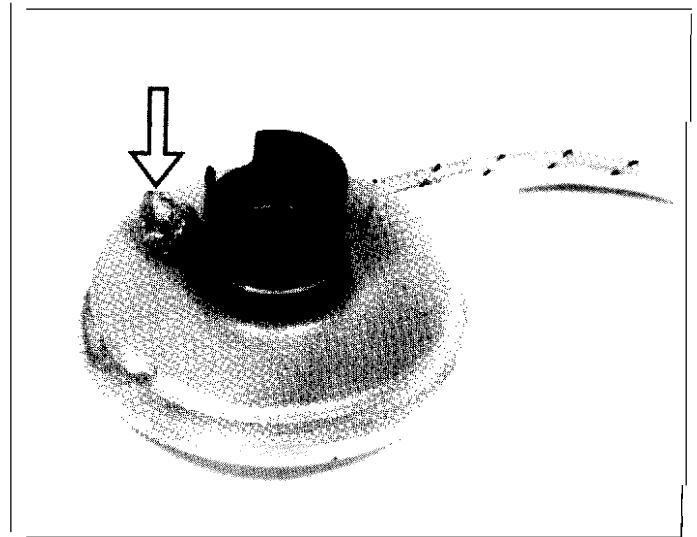

Thread starter cord through retaining ring and eyelet as shown. Attach starter handle to rope.

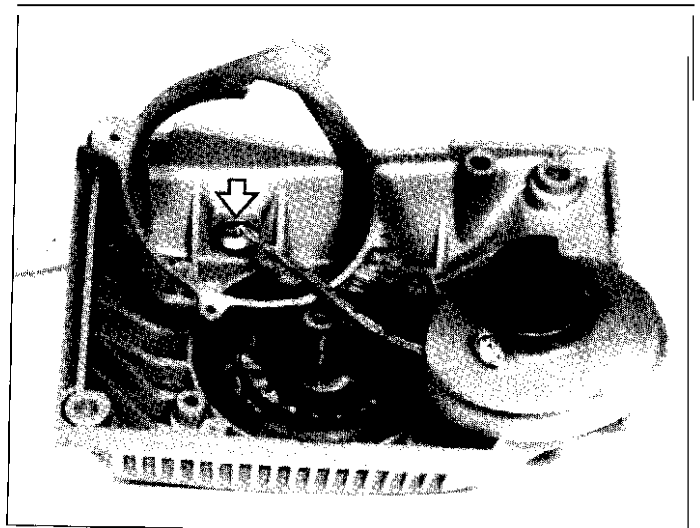

4 Starter

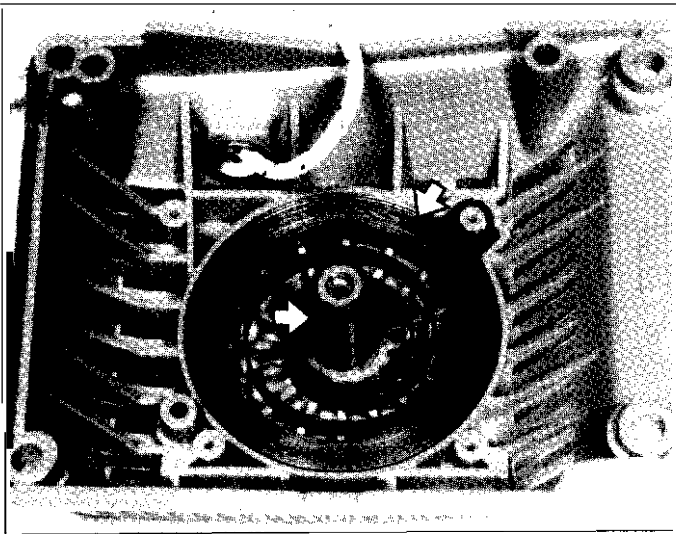

Apply a light coating of oil to starter pulley post and recoil spring.

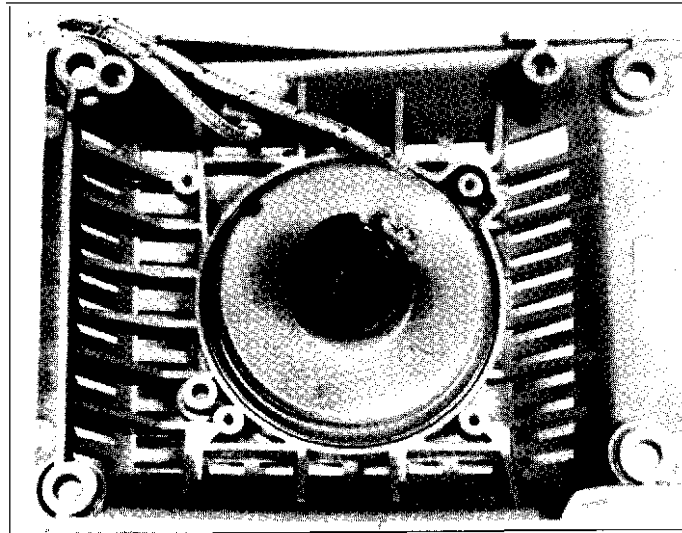

Position starter pulley on starter housing as shown. Rotate pulley to engage recoil spring in pulley.

IMPORTANT: Starter pulley must be flush against recoil spring.

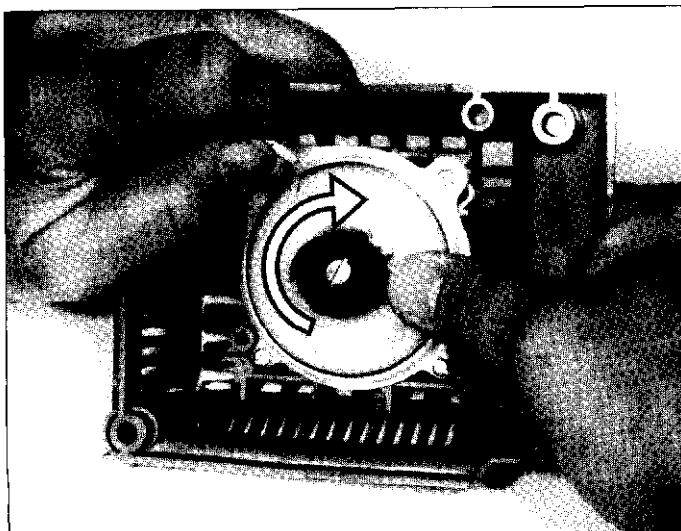

Secure starter pulley with washer and screw. Install guard ring with screws. Pull starter handle out and stop starter pulley with thumb. Lift cord into pulley recess, then preload spring by turning pulley three turns clockwise.

Pull starter cord all the way out. Make sure starter pulley can be turned at least 1/2 turn, before the recoil spring fully tightens.

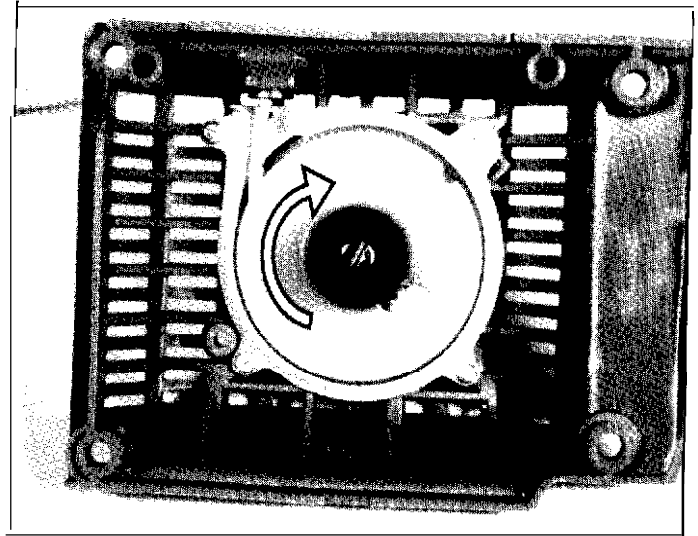

With starter handle extended approximately 30 cm (1 2") from housing, position starter against saw. Release starter handle to allow the pulley to fit within the starter pawls on flywheel. Secure starter with screws.

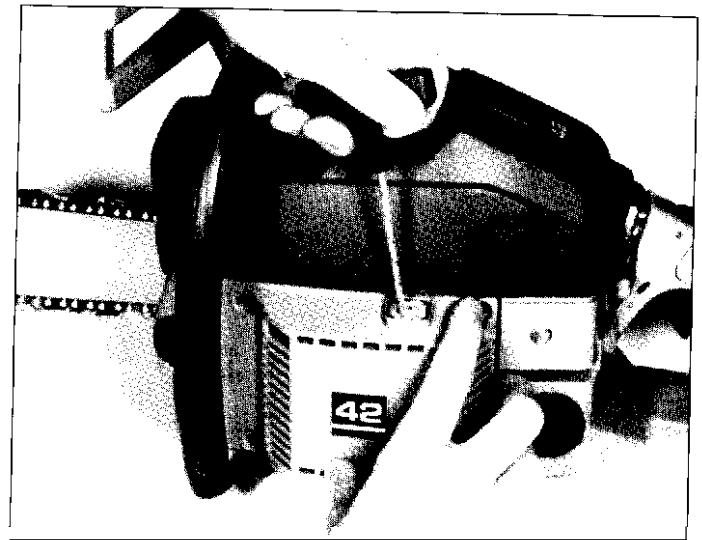

5

Ignition System

Description

Models 42, 42D and 242 are equipped with an electronic ignition system. The spark generated by this system has a higher energy and a shorter burning time than the spark generated by a breaker point ignition. Because of this, the spark, across the spark plug electrode, appears to be weaker.

Checking the Spark

Remove and clean spark plug. Check spark plug electrode gap.

Spark plug gap should be 0.5 mm (.020"). If electrodes are worn, spark plug must be replaced.

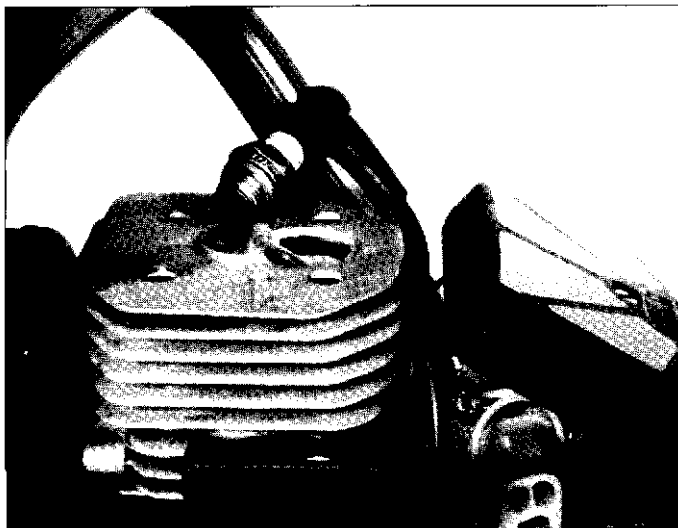
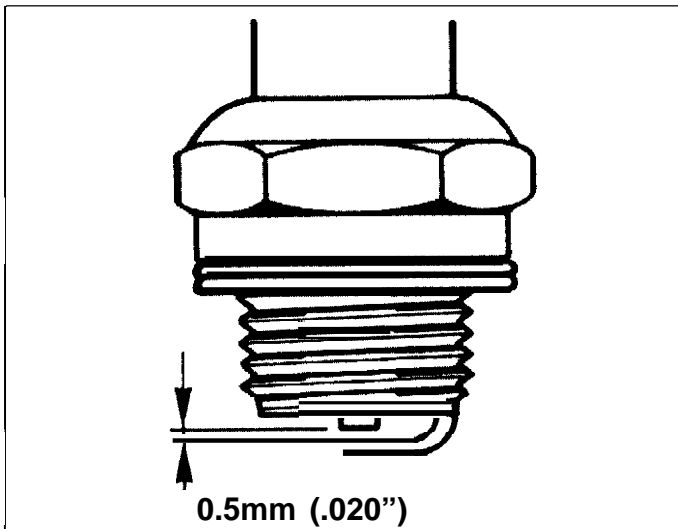

With ON/OFF switch in "ON" position, ground spark plug to cylinder and pull starter handle. A spark should appear across the electrodes.

If no spark appears, install new spark plug or test plug P/N 50271 13-01 and pull starter handle.

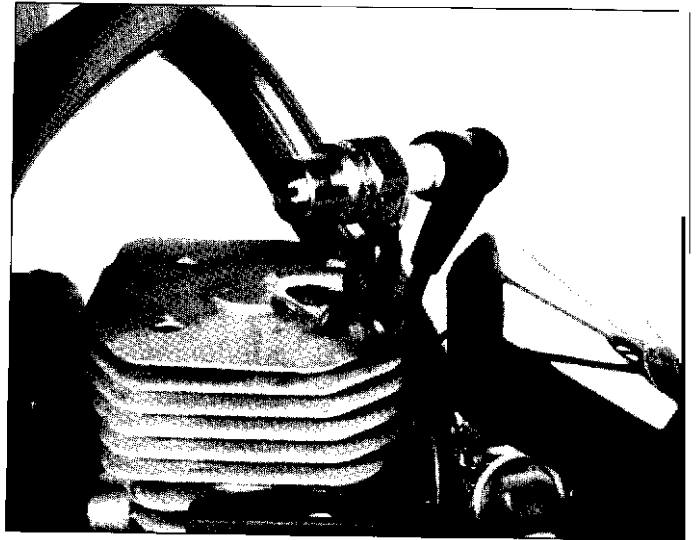

If no spark appears, remove ON/OFF switch lead from stop switch and pull starter handle, if spark appears, stop switch is faulty and must be replaced. If no spark appears, check high tension leads, connections and contacts for dirt, wear and/or damage.

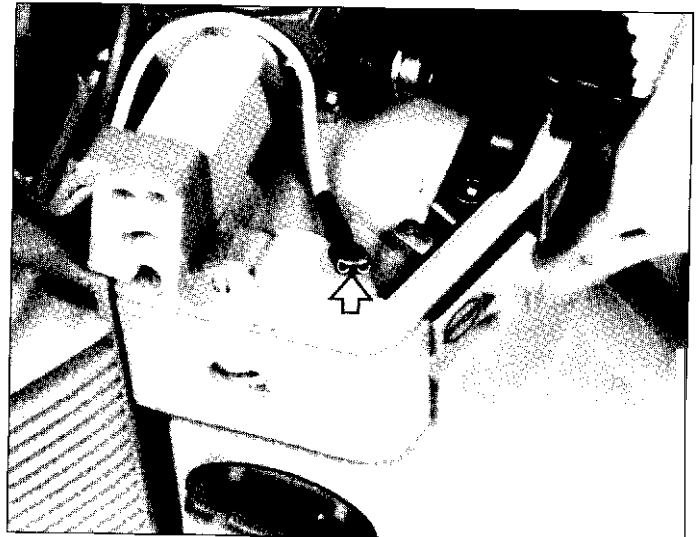

Using air gap gauge P/N 5025134-02 check air gap between flywheel magnet and ignition module. Air gap should be 0.3 mm (.012").



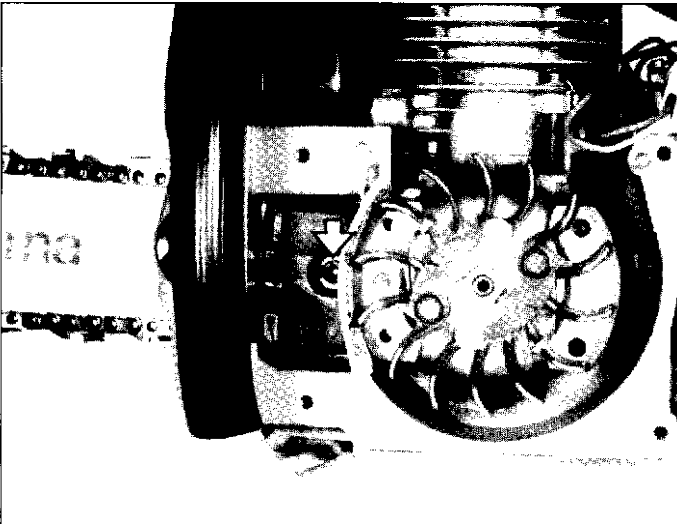

To adjust air gap, loosen ignition module retaining screws. Position air gap gauge between module and flywheel magnets. Press ignition module towards flywheel. Tighten screws and remove air gap gauge. Pull starter handle. If no spark appears, replace ignition module.

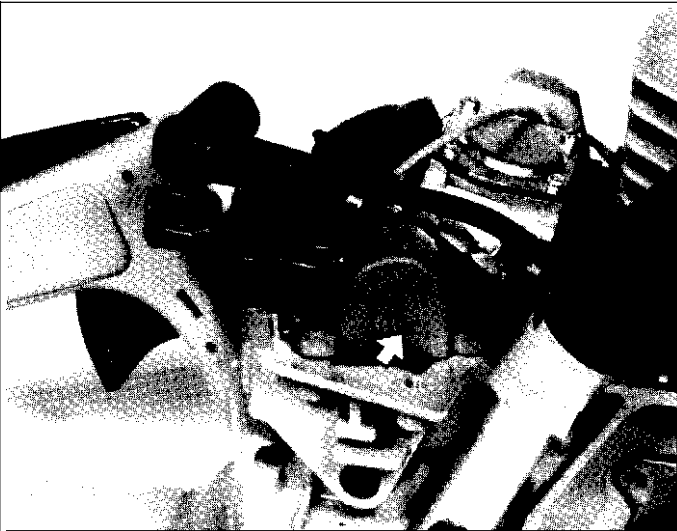

If replacing ignition module does not restore spark, replace coil.

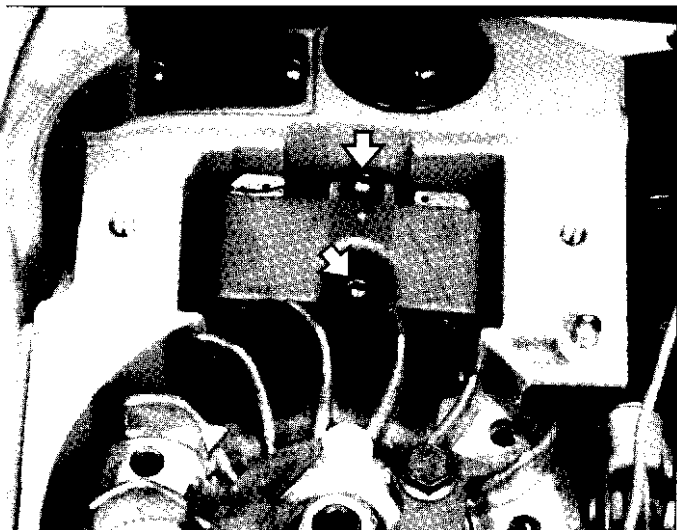

Replacement of the Ignition Module

Remove leads from ignition module. Remove screws and ignition module. Position new ignition module as shown and install but do not tighten screws.

Place air gap gauge P/N 5025134-02 between ignition module and flywheel. Press ignition module against air gap gauge. Make sure flywheel magnets are in line with module and tighten ignition module screws. Remove air gap gauge.



Connect blue ON/OFF switch lead (1) and red coil lead (2) to ignition module. Be sure to route all leads away from flywheel.

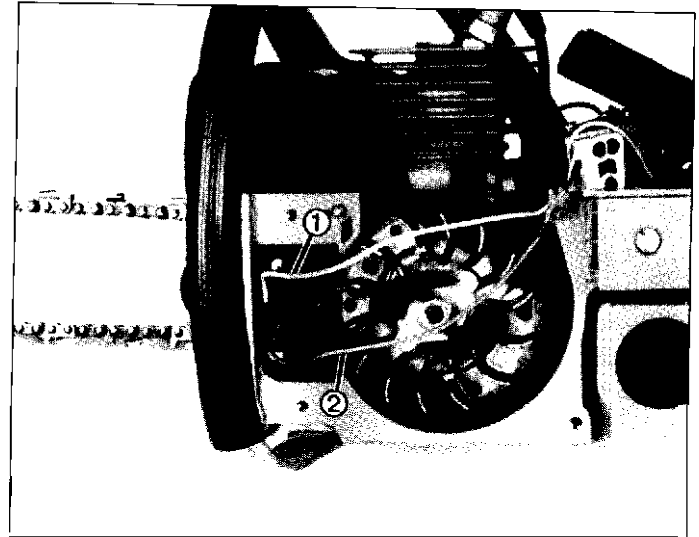

Replacement of the Coil

Remove high tension lead from spark plug. Remove ignition module lead and screws. Remove coil. Position new coil as shown and secure with screws. Connect ignition module lead to coil.

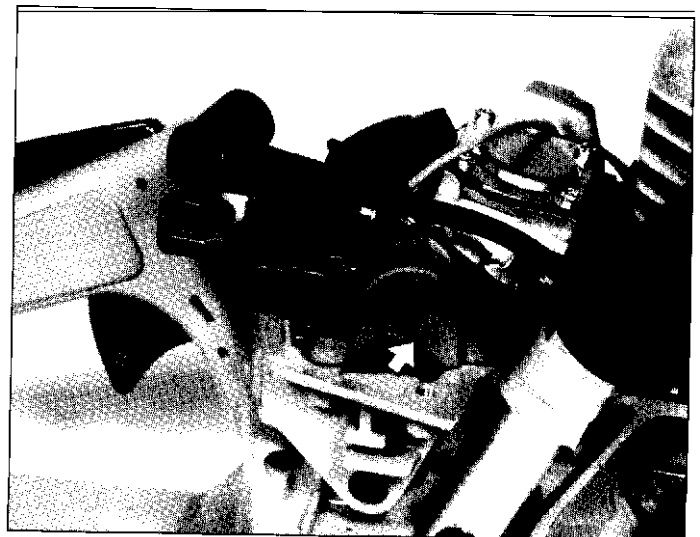

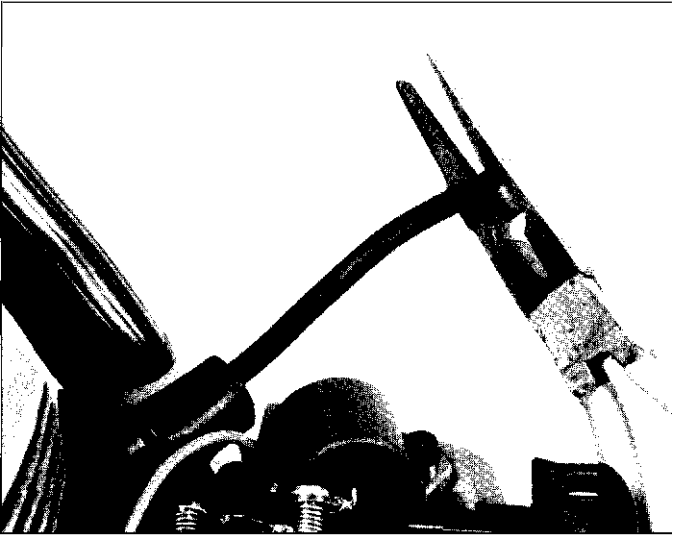

Using assembling pliers P/N 5025006-01, make a guide hole in high tension lead.

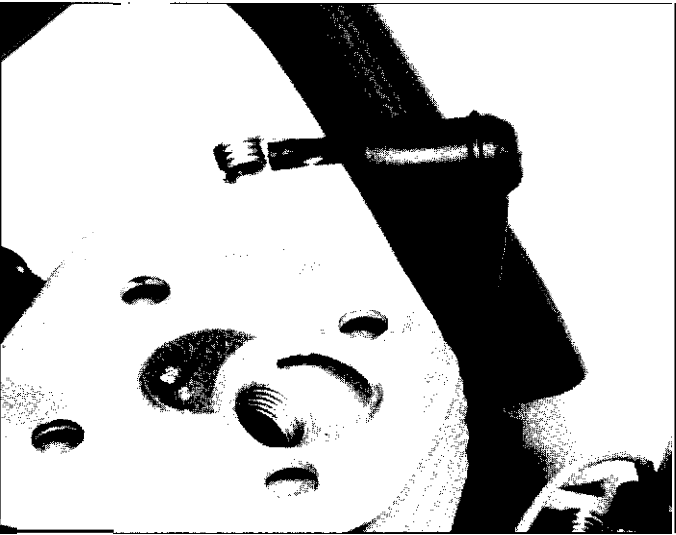

Insert ignition lead through rubber cover and install contact spring in guide hole and secure with assembling pliers. Slide rubber cover over contact spring.

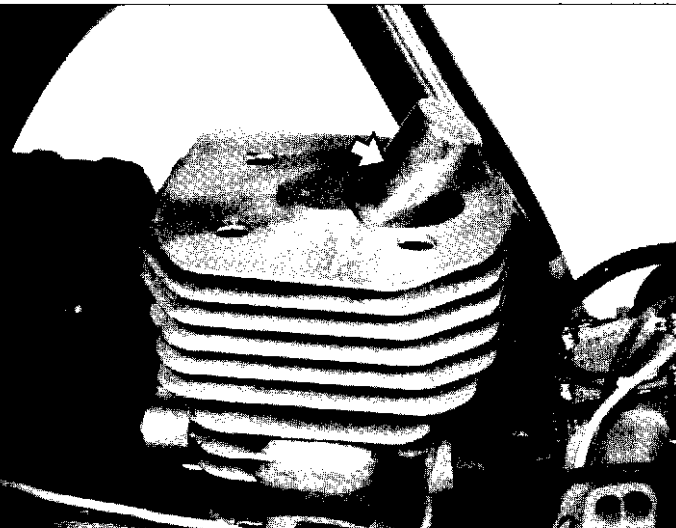

Removal of the Flywheel

Remove spark plug and thread piston stop P/N 5025033-01 into spark plug hole until tight.

Remove flywheel nut and washer (1). Remove starter pawls (2).

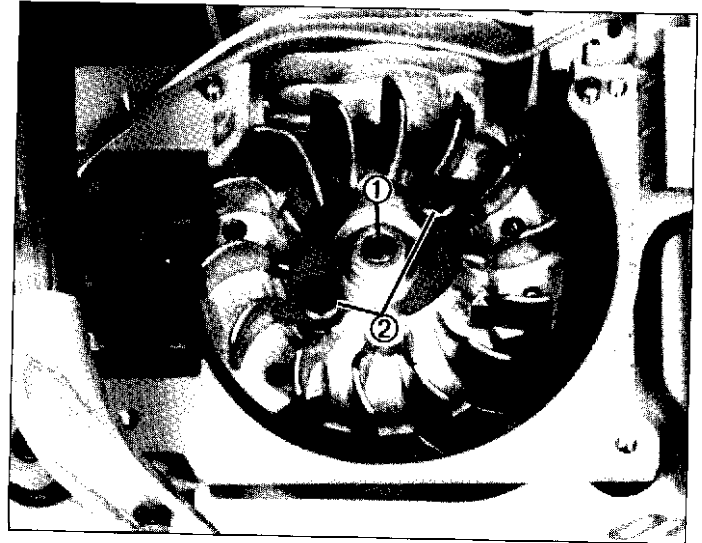

Remove piston stop P/N 5025033-01. Install flywheel removal tool P/N 5025149-01 to the flywheel with the M5 screws. Ensure puller P/N 5025026-01 is centered, then tighten puller screw and lightly tap puller, and remove flywheel.

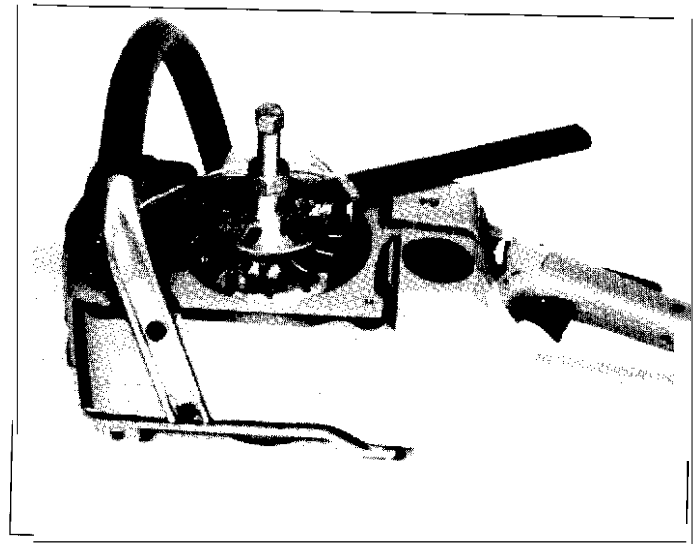

On G series saws (models with heated handles) the generator is now visible and can be removed. The sealing ring holder is located behind the generator.

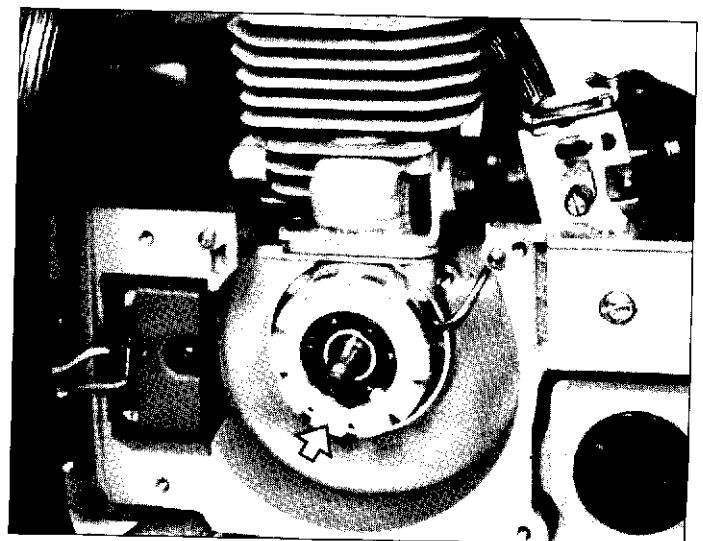

5

Ignition System

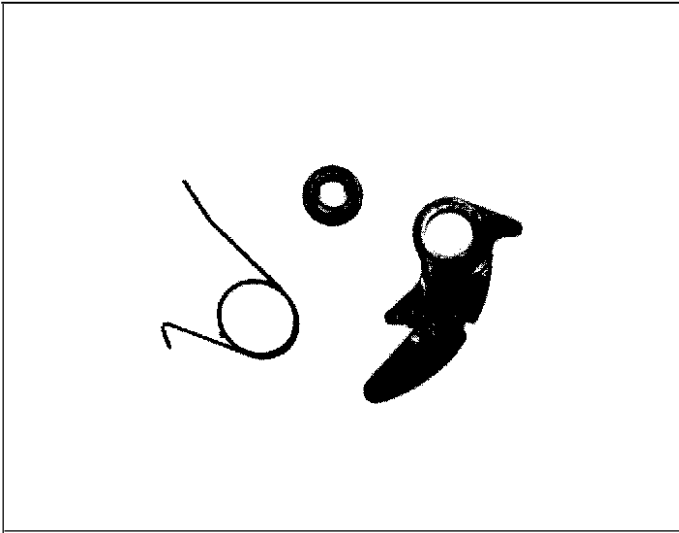

Remove flywheel removal tool from flywheel. Inspect starter pawls for damage or wear. Check pawl return spring tension. Replace parts as necessary.

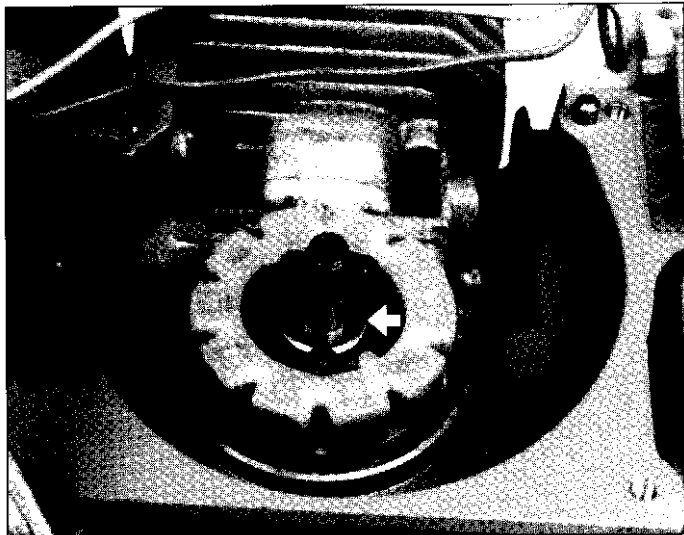

Installation

Install flywheel key in crankshaft keyway and install flywheel.

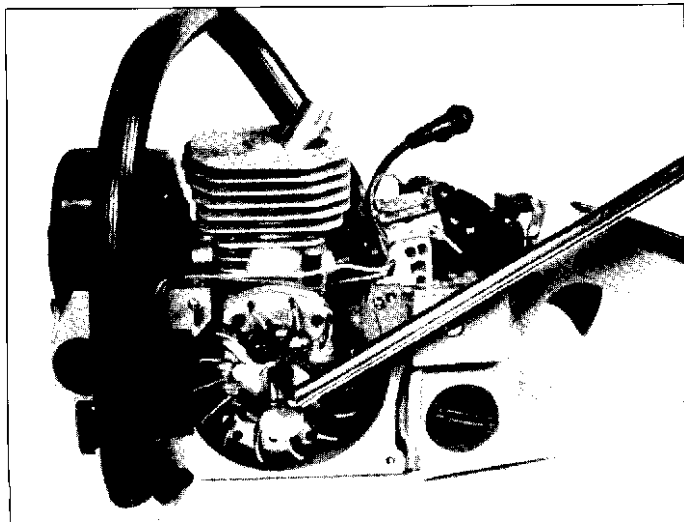

Thread piston stop into spark plug hole until tight. Install flywheel washer and nut. Torque flywheel nut to 24-29 Nm. (17 -21 ft. lbs.) Install starter pawls. Remove piston stop.

IMPORTANT: Starter pawls must move freely.

Identification

The symbol "G" means the saw is equipped with electrically heated front and rear handles. The required electric power is produced by a generator located behind the flywheel. This system requires no maintenance and is controlled by an ON/OFF switch on the right side of the saw.

Checking the Switch

Remove lead from switch. Connect ohmmeter to crankcase (1) and lead connector (2). Slide switch to "ON" and then "OFF" position. When the switch is in the "ON" position the needle should move. When the switch is in the "OFF" position the needle should show no movement.

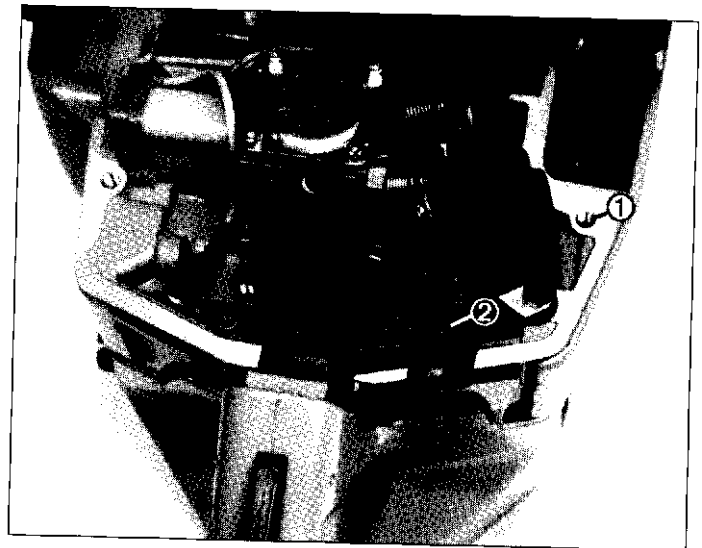

Handle Element

Oxidation of lead connections and rear socket are common causes of element failure. Clean elements as needed.

6

Heated Handles

Checking the Rear Handle Element

With heater switch in the "OFF" position, test the two heating elements in the rear handle between points 2 and 3. The meter should read 1.4 -1.8 ohms. Connect meter between points 4 and 2 and then between 4 and 3. The meter should read 0.7 -0.9 ohms in both positions.

Checking the Front Handle Element

With heater switch in the "OFF" position, test between points 1 and 3. Meter should read 3.7 -3.9 ohms. If the reading is below 3.7 ohms, the entire front handle must be replaced.

Checking the Complete Heating System

Test both rear and front handles as follows. With heater switch in the "OFF" position, connect meter between points 1 and 2. Meter should read 5.1 -5.7 ohms.

Checking the Generator

- WARNING -

Never start chain saw without bar chain and clutch cover installed. The clutch could come loose and cause severe injury



A voltmeter capable of reading AC voltage is needed to test generator.

Start saw and move heater switch to "ON" position. With saw running at 10000 rpm attach voltmeter leads to point 1 and crankcase. Meter should read 20 volts at 10000 rpm. A low reading can be caused by interruption in generator windings, insufficient magnetization or defective leads.

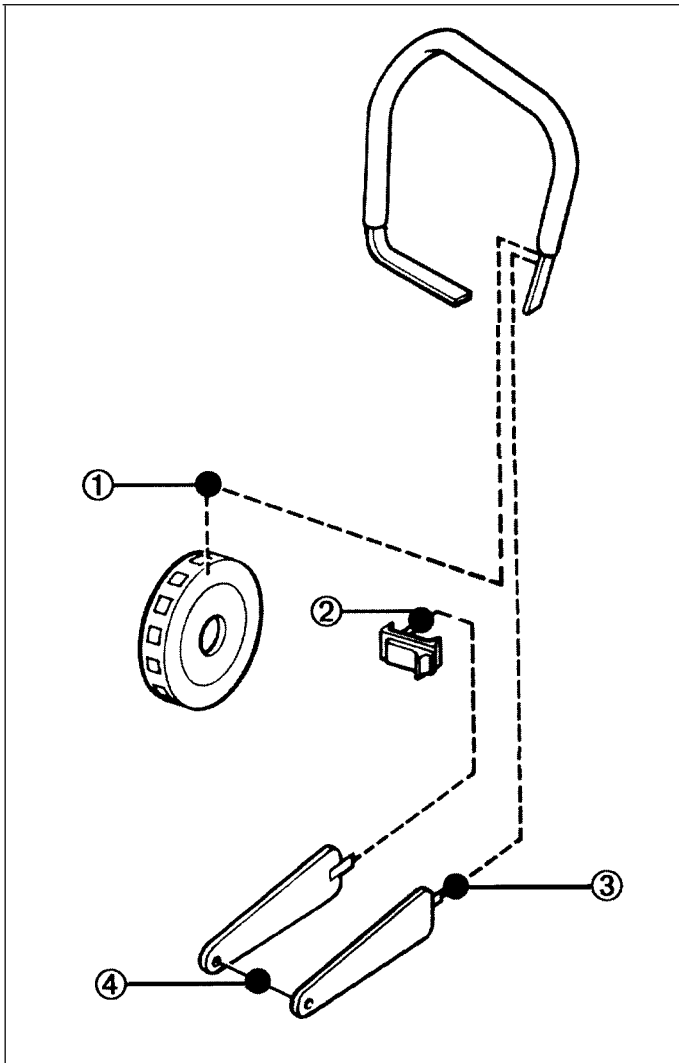

Disassembly

Remove clutch cover, chain and bar. Remove cylinder cover. Remove spark plug. Thread piston stop P/N 5025033-01 into spark plug hole until tight.

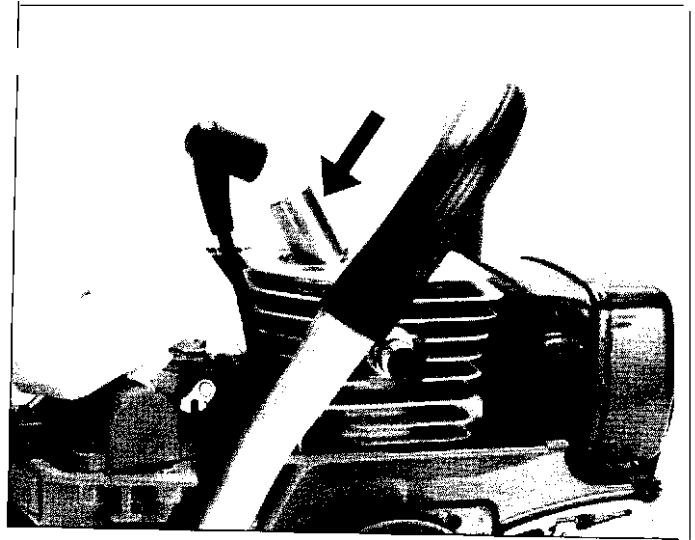

Loosen the clutch, turn wrench in direction of arrow (clutch has left hand threads).

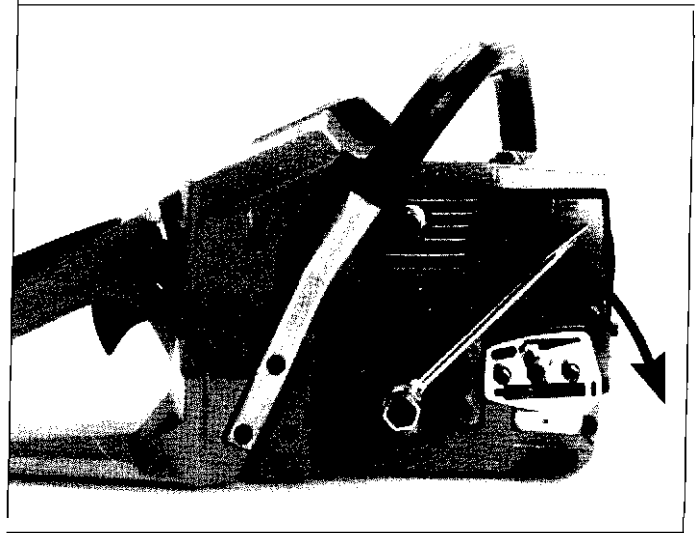

Remove clutch drum. On 242 models, remove rim sprocket.

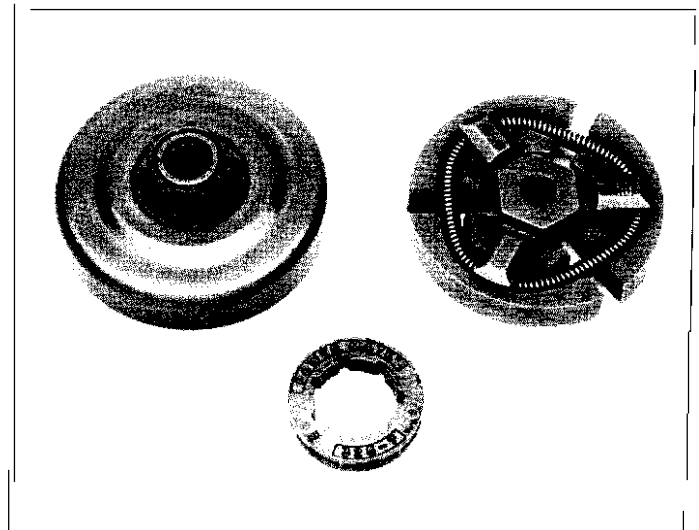

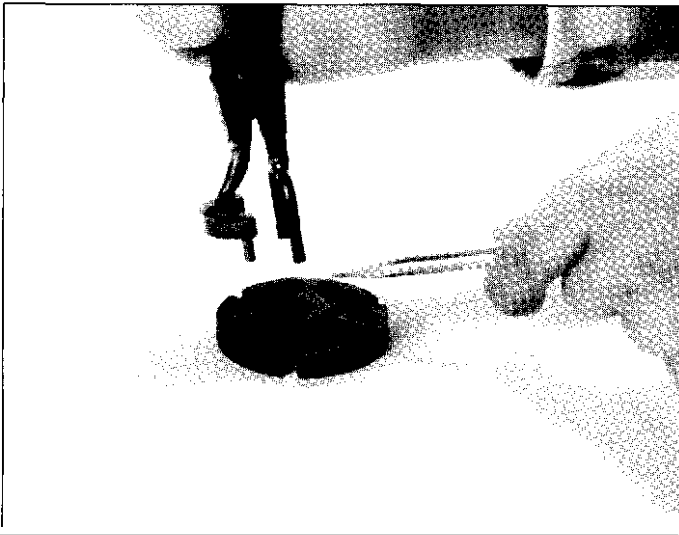

Dismantle the clutch spring. Use a pair of pliers P/N 5025049-01 and a small screwdriver.

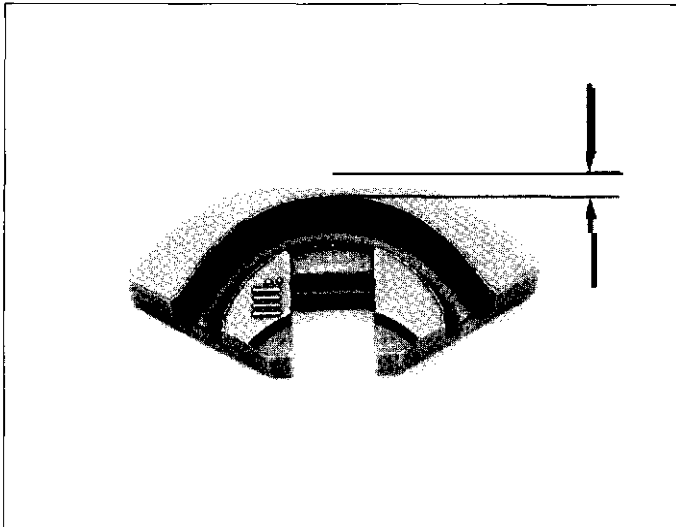

Inspection

Check the wear on the clutch shoes. There must be at least 1 mm of material left at the most worn part. The complete clutch has to be exchanged in order to avoid unbalance.

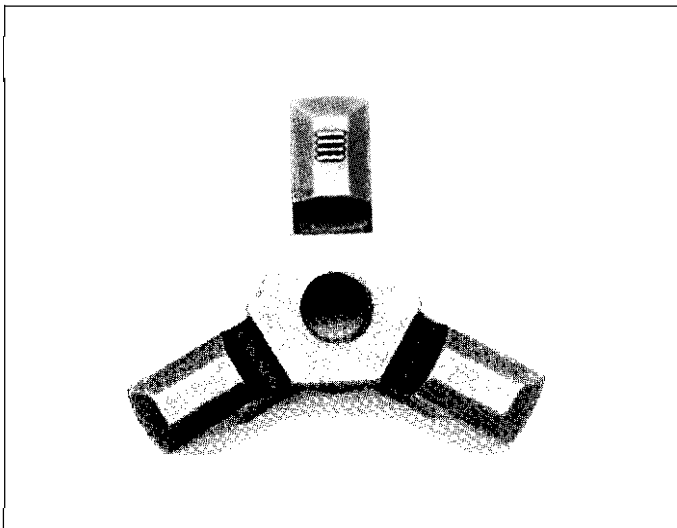

Check the wear on the spokes of the clutch center. Excess wear causes a jarring sound and poor function.

Check chain sprocket and clutch drum for wear or damage. Replace as necessary.

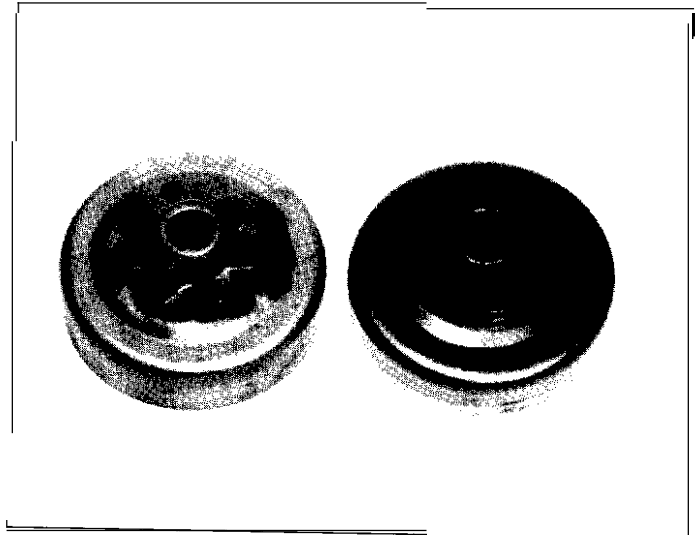

Assembly

Put the spring in one of the clutch shoes so that the spring end loop lies in the middle of the shoe and mount it to the hub. Place an additional clutch shoe on the hub.

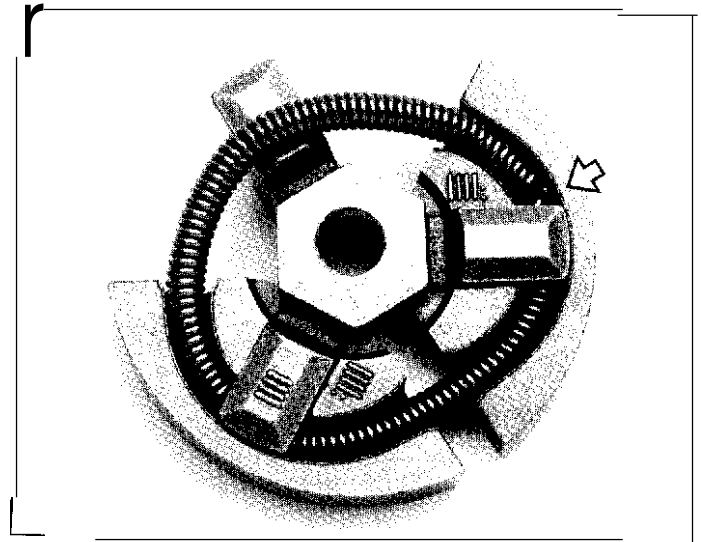

Fit the remaining clutch shoe. Use a pair of pliers, P/N 5025049-01 and a screwdriver.

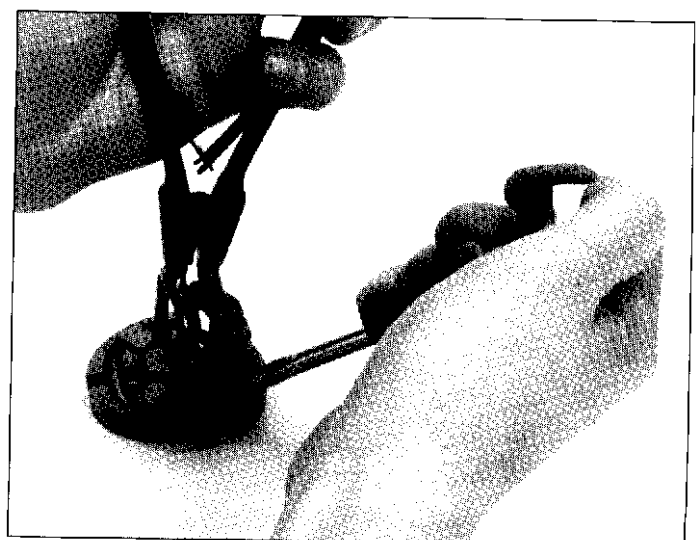

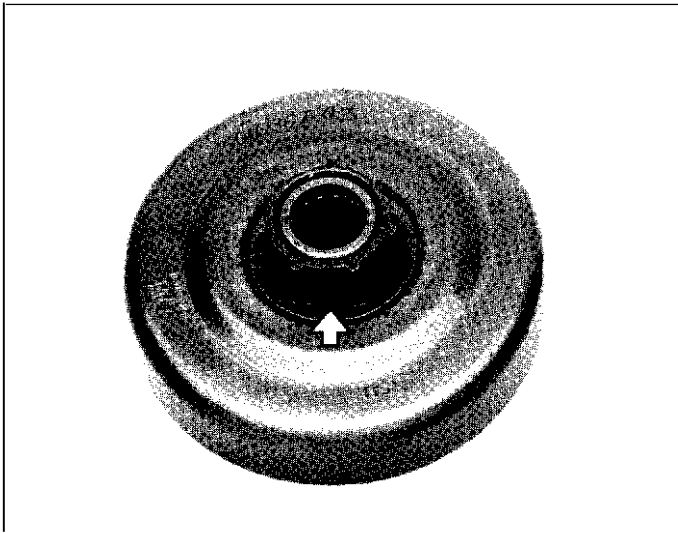

On 242 models, install rim sprocket on clutch drum.

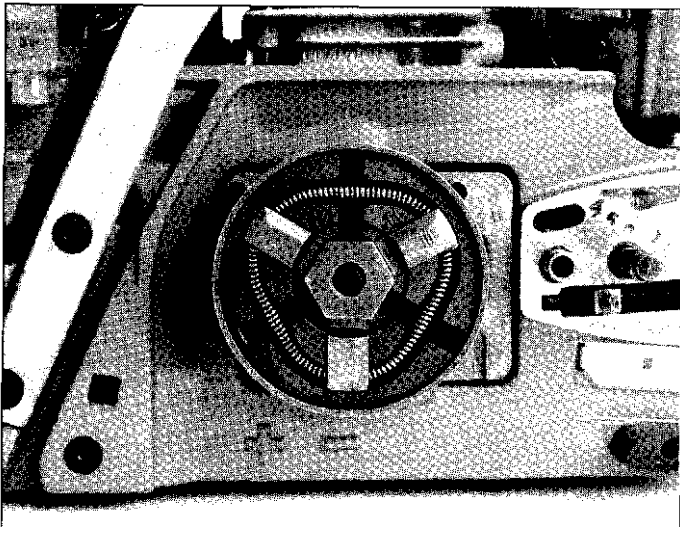

Install clutch drum on crankshaft. Thread clutch counterclockwise onto crankshaft. Clutch assembly must be secure on crankshaft. Apply grease to needle bearing through hole in crankshaft. Remove piston stop. Install spark plug and cylinder cover. Install bar, chain and clutch cover.

- WARNING -

Never start chain saw without bar chain and clutch cover installed. The clutch could come loose and cause severe injury



For Husqvarna Parts Call 606-678-9623 or 606-561-4983

Chain Lubrication System

Disassembly

Remove oil tank filler cap. Dispose of oil properly and flush out oil tank with solvent. Remove debris from tank using low pressure air. Remove clutch cover, chain, bar and clutch assembly. Remove three screws from oil pump.

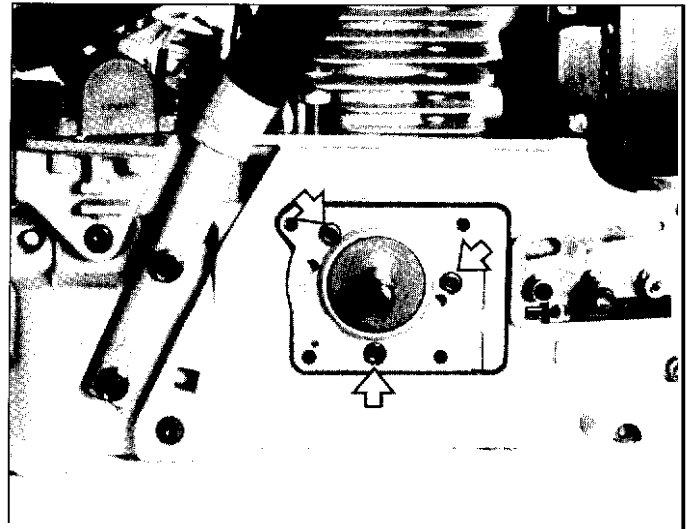

Thread two M5 screws into pump housing as shown. Tighten screws alternately half a turn each time until pump housing comes loose. Remove pump housing and M5 screws.

Note: Removal of the oiler also removes the dust cover washer on the crankshaft.

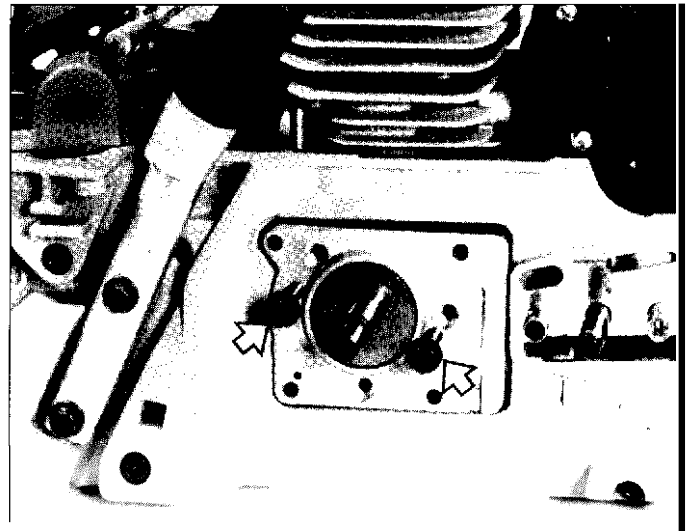

Lift oil suction hose and filter from oil tank and clean or replace oil pick-up filter.

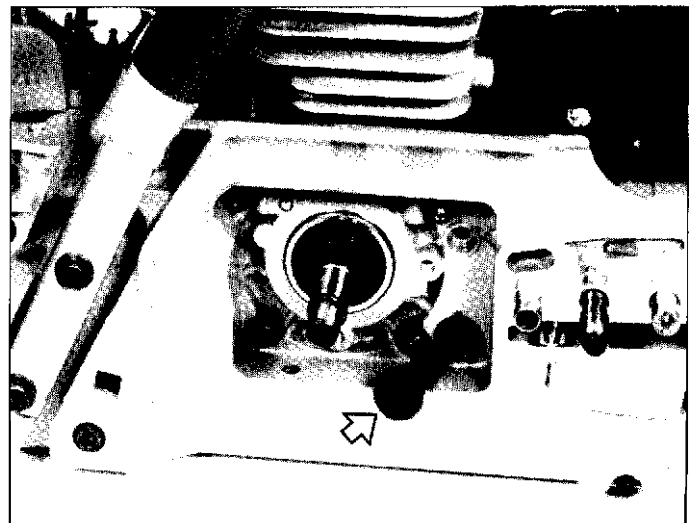

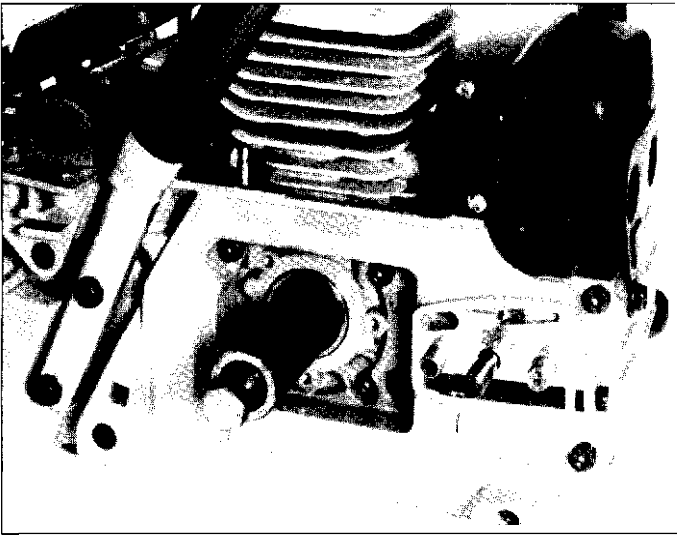

Screw oil gear puller P/N 5053818-17 completely onto worm gear clockwise. Screw puller bolt into sleeve and remove worm gear from crankshaft.

Oil Pump

Disassembly

Loosen screw 1. Remove screw 2.

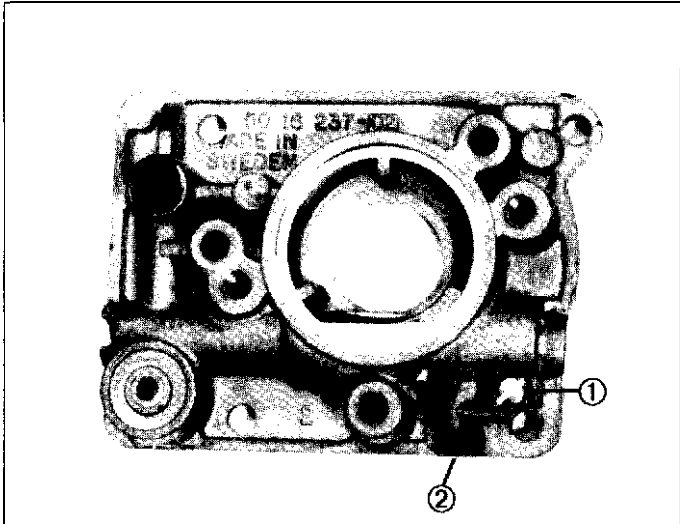

Tap pump housing against sturdy surface to remove sealing plug and pump piston.

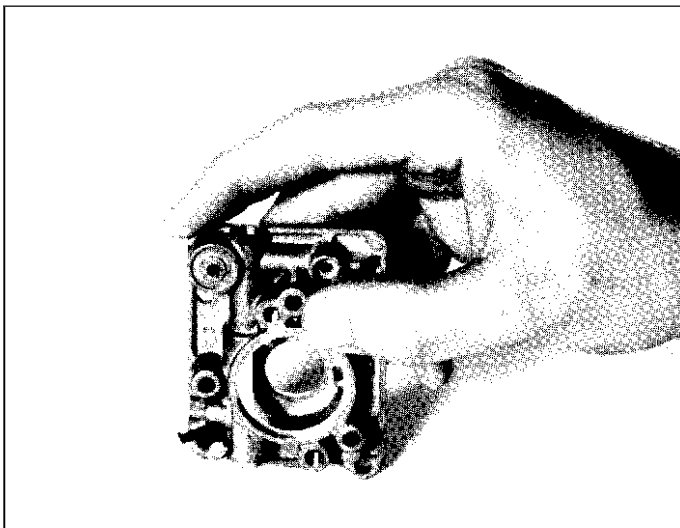

Assembly

Lubricate pump parts with chain oil. Push pump piston to bottom of housing. Install and seat adjusting screw (1). Back adjustment screw out 1-1/2 turns for initial adjustment.

Make sure locking tabs fit in groove of adjusting screw. Tighten lock screw (2). Press in sealing plug (3) and install rubber output sleeve (4).

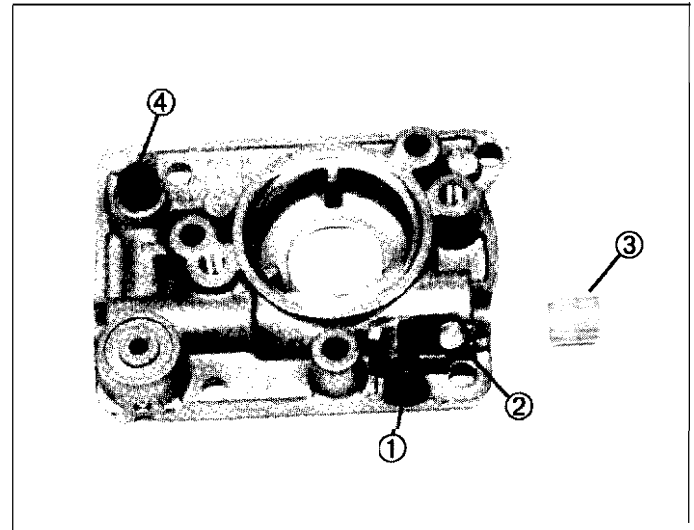

Thread worm gear into puller sleeve until flush with end of sleeve. Place sleeve with gear over the end of the crankshaft. Tap sleeve down with a plastic hammer until gear contacts the shoulder on the crankshaft.

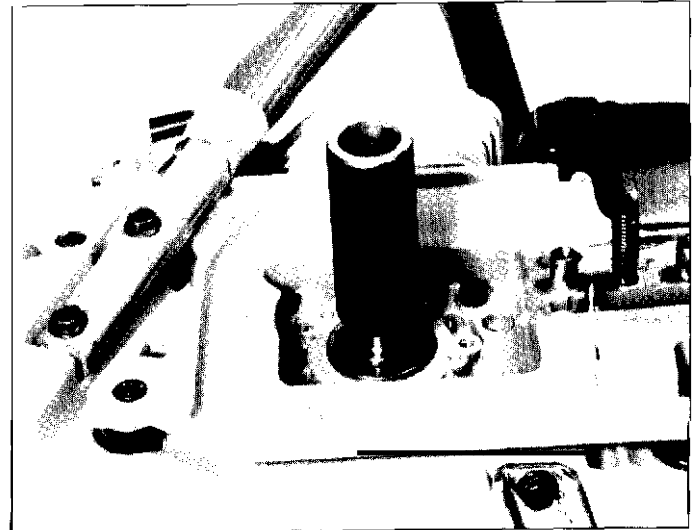

Place suction hose with filter in oil tank opening.

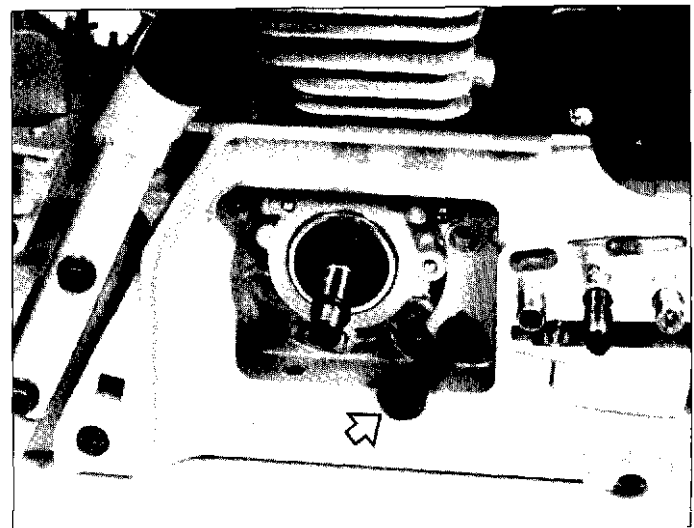

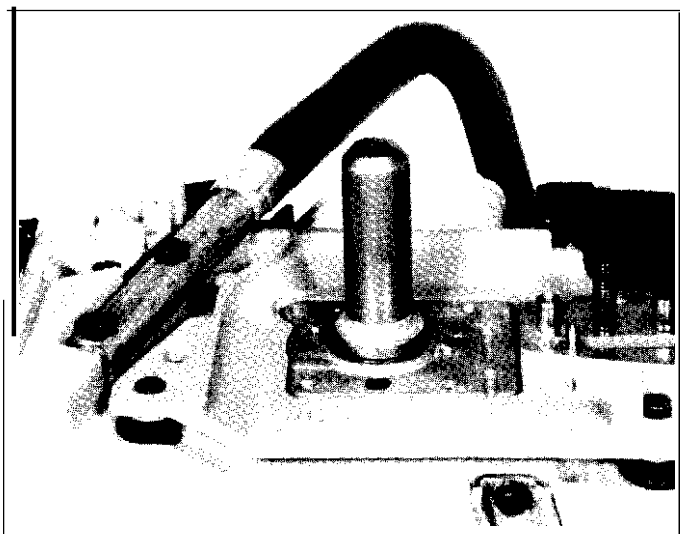

Coat worm gear and oiler drive gear with light petroleum grease.

Install oil pump and secure with screws. Install washer with labyrinth seal against pump. Using a seal driver securely seat the washer.

Install clutch assembly, bar, chain and guide bar cover.

System Description

The powerhead, bar and chain are isolated from the front and rear handles by four shock mounts. These shock mounts are designed to reduce the vibration at the operator's hands which is generated by the powerhead and the cutting equipment.

Replacement of the Shock Mounts

Empty fuel tank. Remove clutch cover, chain, bar, cylinder cover, air filter and starter assembly.

Disconnect fuel hose. On "G" models, disconnect leads from generator to handles at connectors. Remove four shock mount screws. Separate fuel tank assembly and front handle from powerhead.

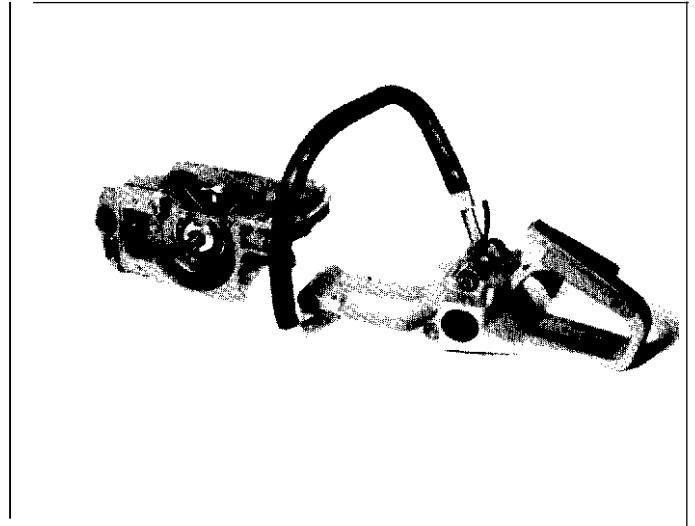

Remove the four shock mounts using 11 mm spanner P/N 5025067-01. Install and secure new shock mounts with 11 mm spanner.

IMPORTANT: All 4 shock mounts must be replaced as a set.

Position remaining two shock mounts and reassemble saw.

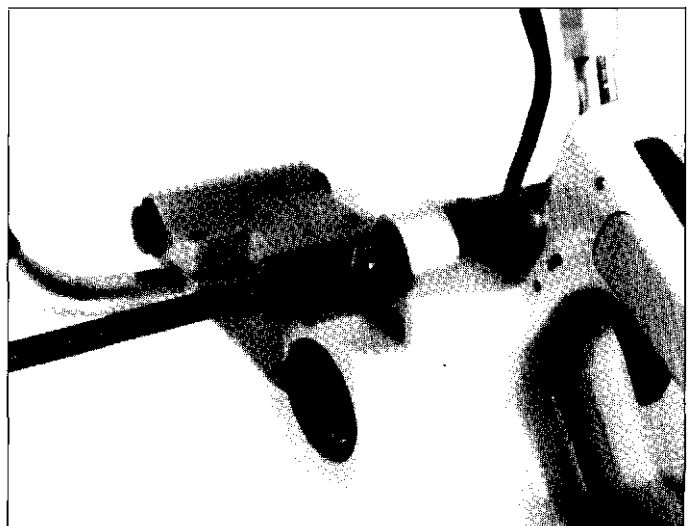

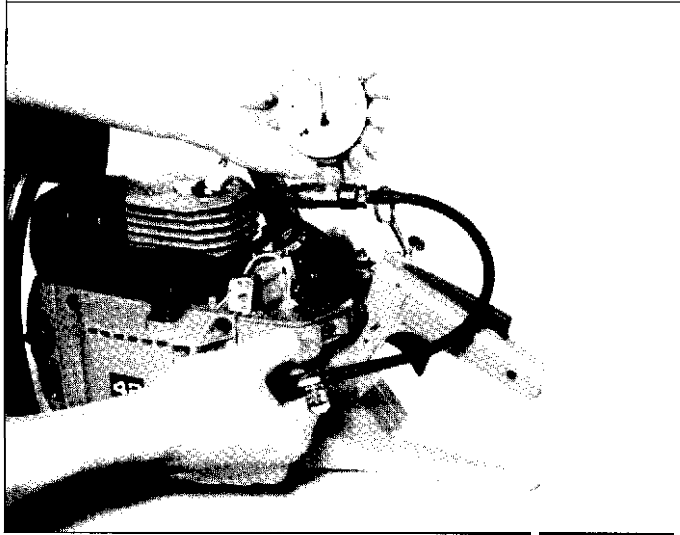

Checking the Fuel Tank Ventilation

Empty fuel from tank into a suitable container. Remove cylinder cover. Remove fuel hose from carburetor. Install and tighten fuel tank cap. Connect pressure gauge P/N 5025038-01 to fuel hose. Pump gauge to 50 kPa (7 psi). Pressure should drop to 20 kPa (2 psi) within 60 seconds.

NOTE: Rate at which pressure drops can vary depending on type of two stroke oil used in fuel.

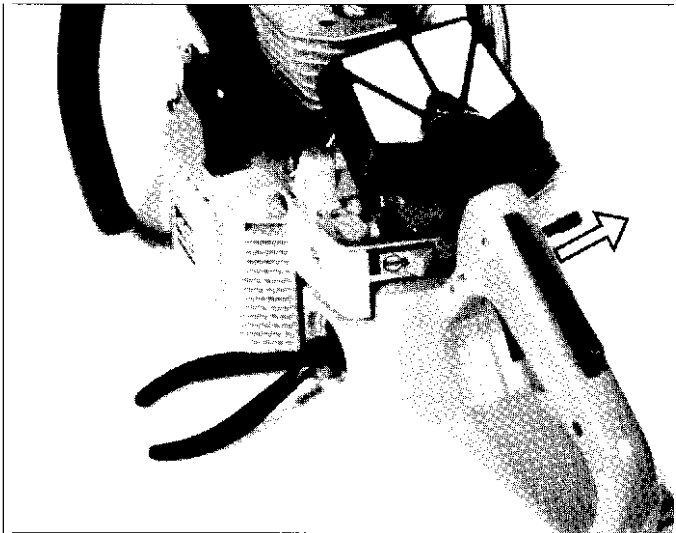

Replacement of the Vent

Remove fuel tank cap completely. Using a curved needle nose pliers, grip vent tube and push vent out through passage.

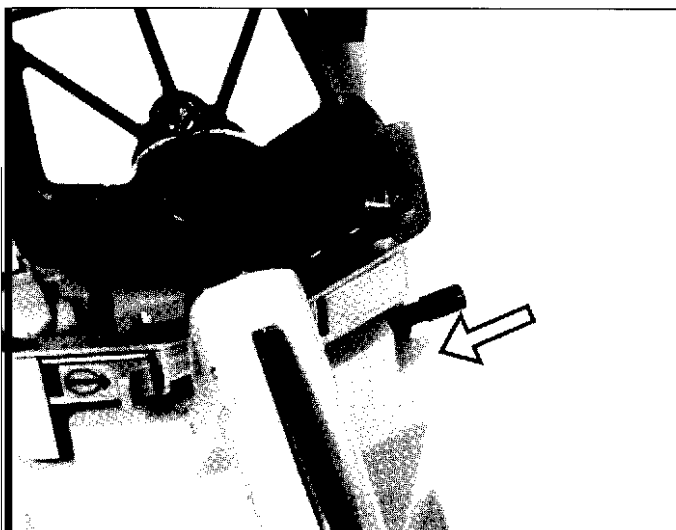

Using a suitable punch, push new fuel tank vent into place. Some vents are threaded and require a screwdriver.

Replacement of the Fuel Filter

Remove fuel tank cap completely. Using hook P/N 502 50 83-01, pull fuel filter from fuel tank. Remove fuel filter from hose and install new filter.

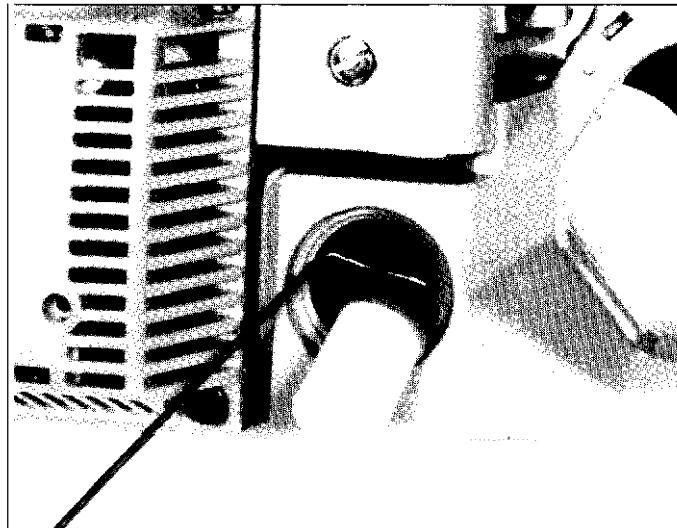

Carburetor

- WARNING -

Never start chain saw without bar, chain and clutch cover installed. The clutch could come loose and cause severe injury.



Adjustment

Clean air filter and fuel filter before adjusting carburetor.

There are three adjustment screws on the carburetor:

- L = Low speed screw
- H = High speed screw
- T = Idle speed screw

Turn screws L and H clockwise until lightly seated. Turn screw L counterclockwise 1-1/2 turns. Turn screw H counterclockwise 1-1/4 turns.

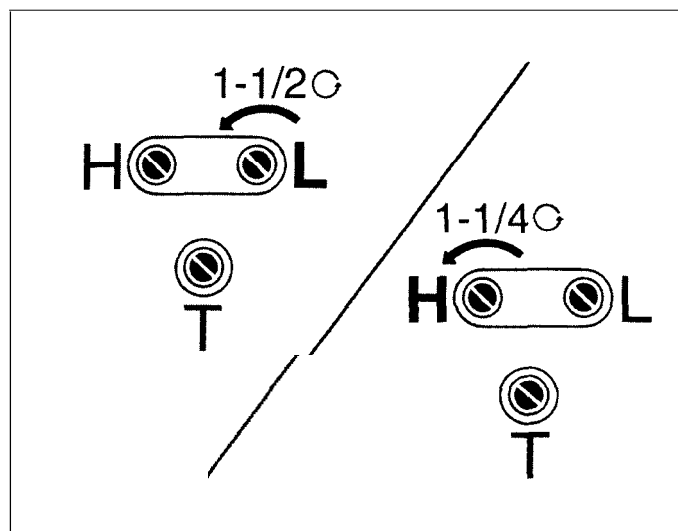

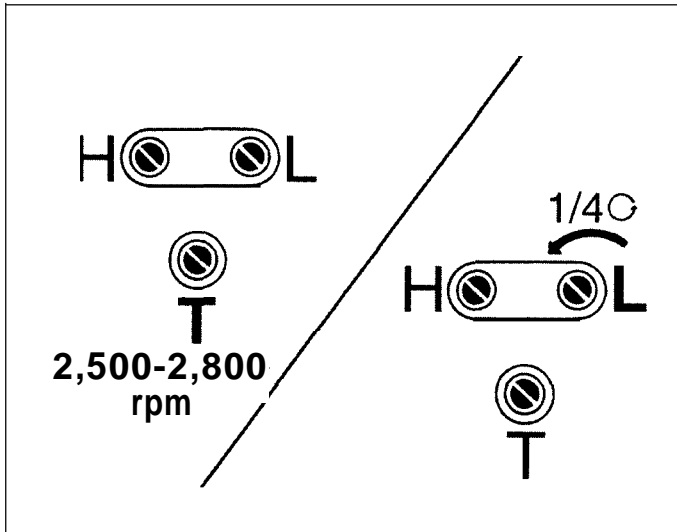

Start saw and allow to warm up. Adjust screw T until saw idles between 2500-2800 rpm or just below clutch engagement.

Turn screw L clockwise just until engine rpm decreases (lean drop). Note this position, then turn screw L counterclockwise until engine rpm decreases (rich drop) and note this position. Set screw L between lean and rich positions. Make sure engine does not hesitate on acceleration and saw chain doesn't rotate at idle.

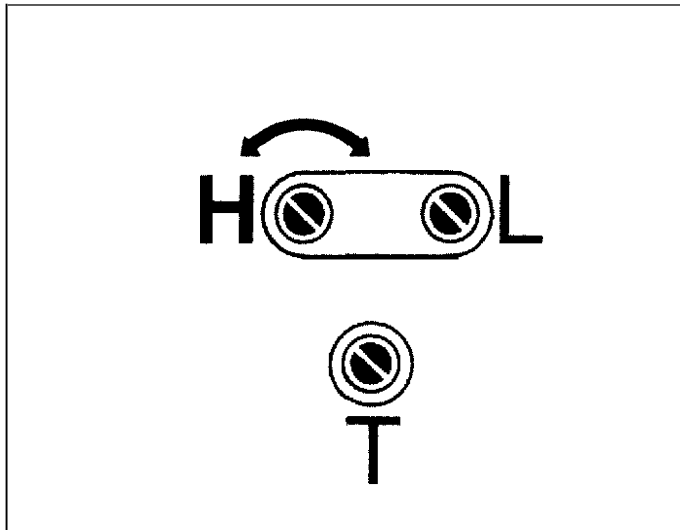

Adjust screw H for optimum cutting performance under load. Using a tachometer, ensure maximum no load rpm does not exceed 14000 for 42, 42D models and 15500 for 242 models.

caution: Do not adjust carburetor less than 7/8 turn open on (H) needle, this can cause an over speeding condition and possible lack of lubrication.

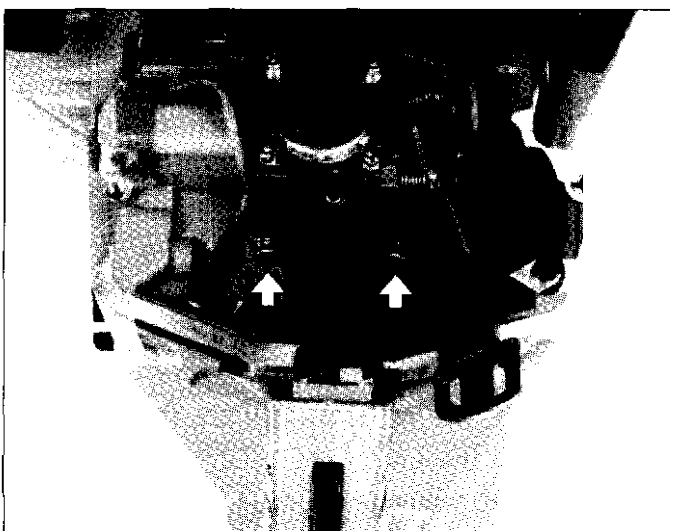

Removal of Carburetor

Remove cylinder cover. Remove air filter. Disconnect choke linkage. Remove fuel hose and, if equipped, heated handle switch lead.

Remove (2) screws. Lift and turn carburetor to disconnect throttle linkage.

Remove screw (1), washer (2), filter holder (3), gasket (4), manifold (5), gasket (6) and screw-driver guide (7) from carburetor.

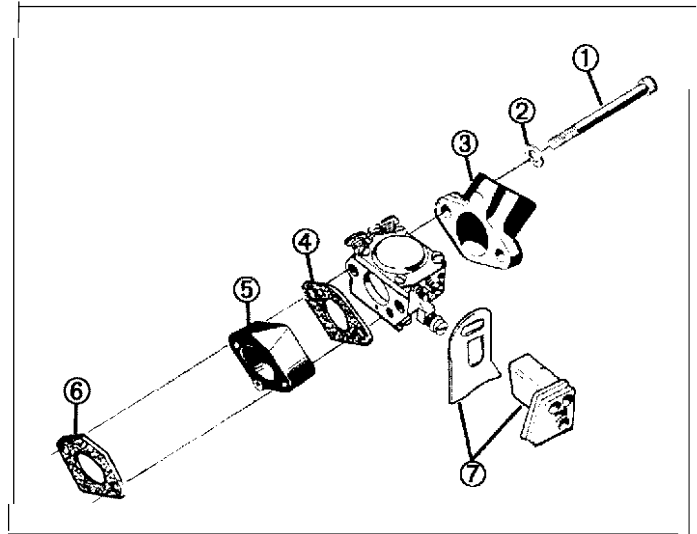

Metering Side

Disassembly

Remove screws (1). Remove metering diaphragm cover (2) and metering diaphragm (3).

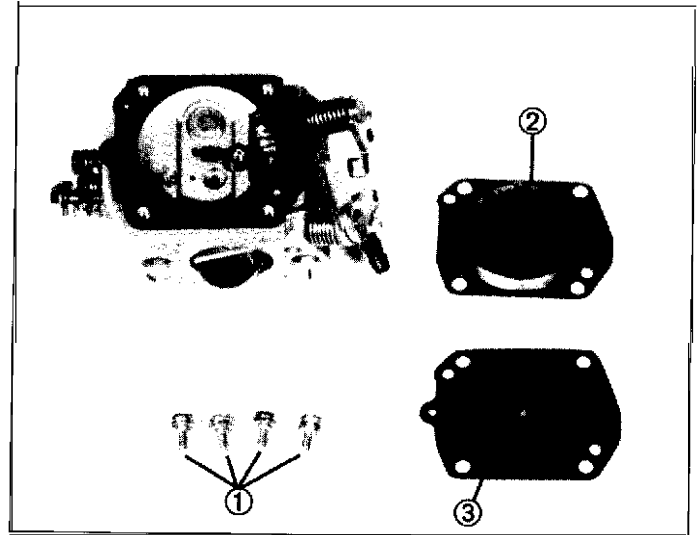

Connect pressure gauge P/N 5025038-01 to fuel hose nipple and submerge carburetor in a container of non-flammable clear solvent. Test pressure at 50 kPa (7 psi). No leakage permitted.

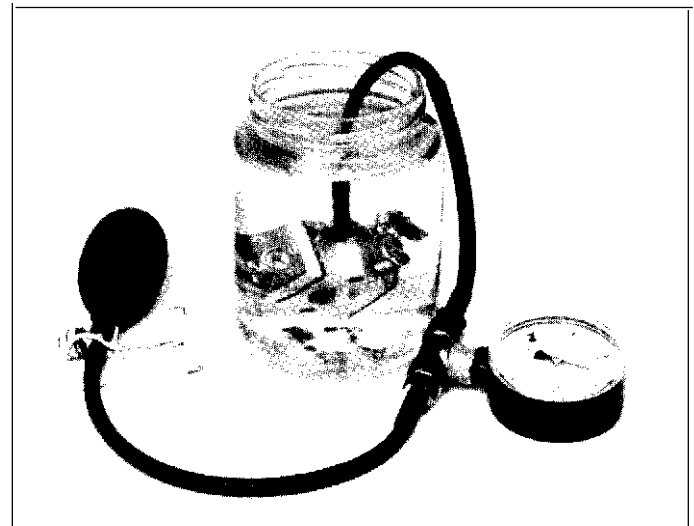

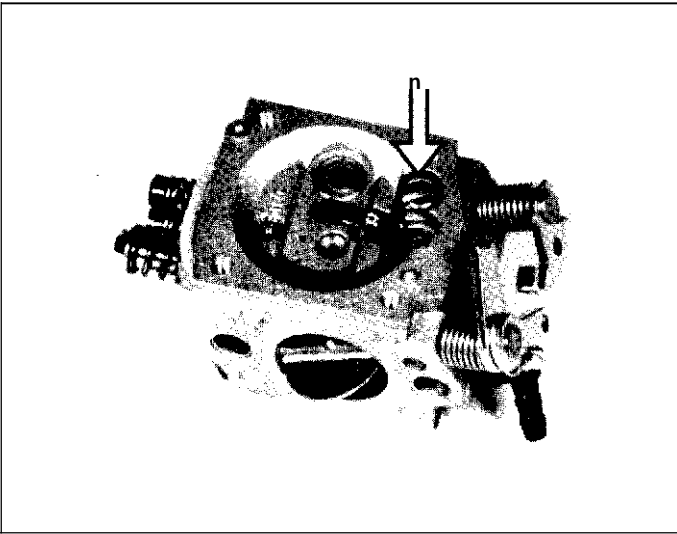

If leakage occurs, loosen screw and remove needle valve.

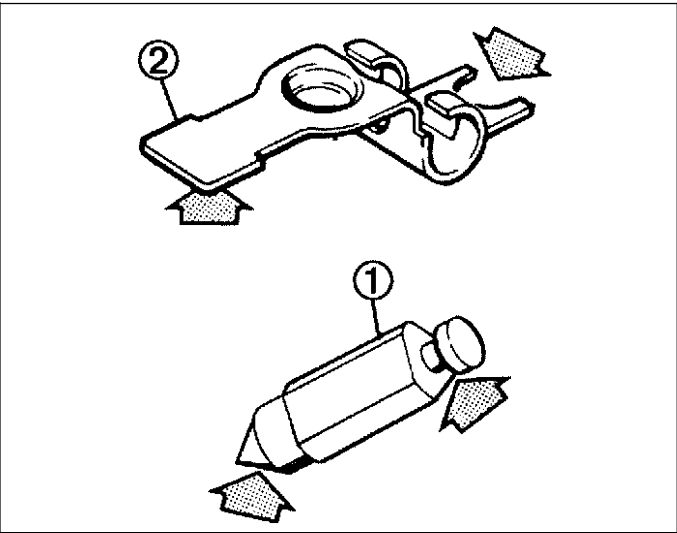

Inspect needle valve (1) and lever (2) for wear or damage. Replace if necessary.

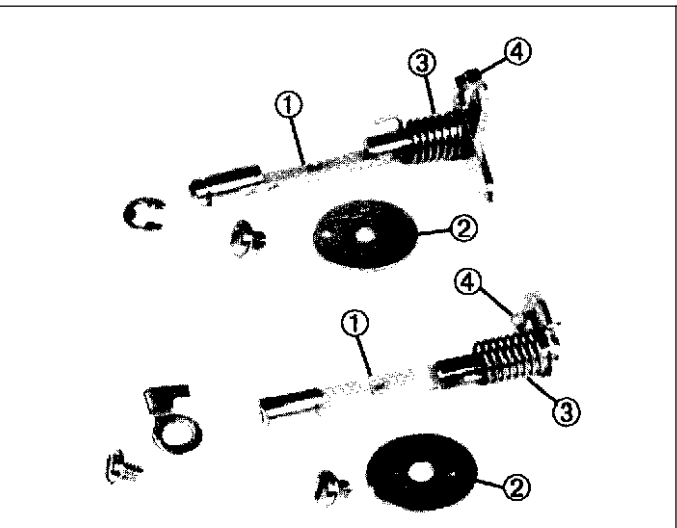

Check shafts (1), choke and throttle plates (2), springs (3) and fast idle levers (4) for wear or damage. Replace if necessary.

Fuel Pump

Disassembly

Remove screw (1). Remove fuel pump cover (2), gasket (3) and diaphragm (4).

NOTE: The internal passages of the carburetor body are delicate and are easily damaged if proper service procedures are not used. Damage to the fuel passages and seats is not repairable and will necessitate the installation of a new carburetor. Make sure the work area is clean and exercise extreme care during disassembly, cleaning and reassembly of the carburetor.

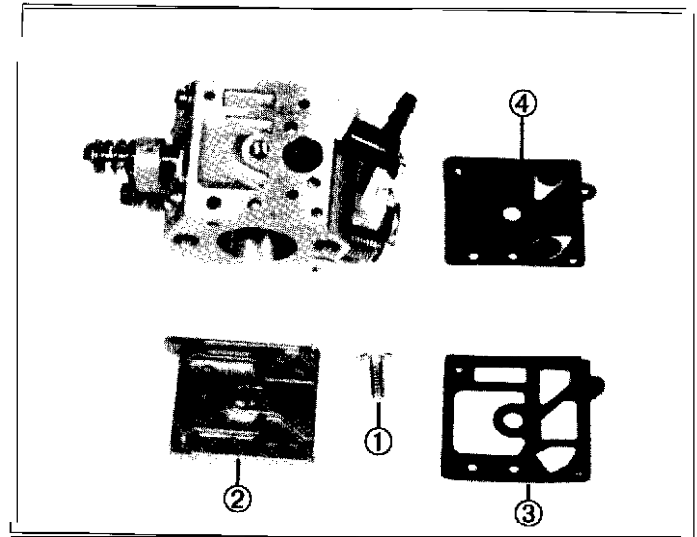

Drill a small hole in welch plug (1) and cup plug (2). Place a screwdriver in hole and pry out plugs. Remove fuel screen (3). Remove adjusting needles and springs (4). Clean carburetor housing and parts in suitable solvent and dry with low pressure air.

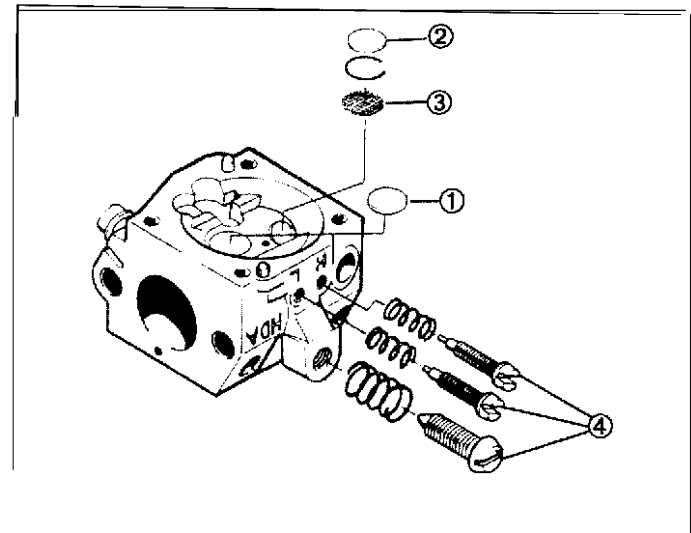

Assembly

Install new fuel screen (3). Tap new welch plug (1) and cup plug (2) into place. Seal plugs with nail polish. Install springs and adjusting needles (4).

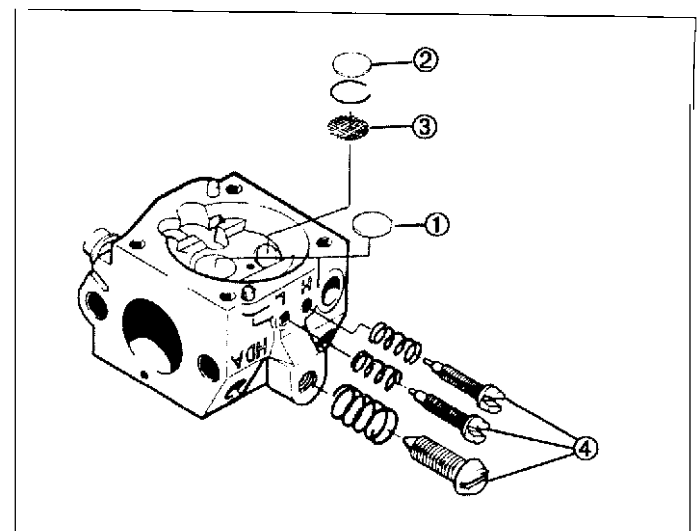

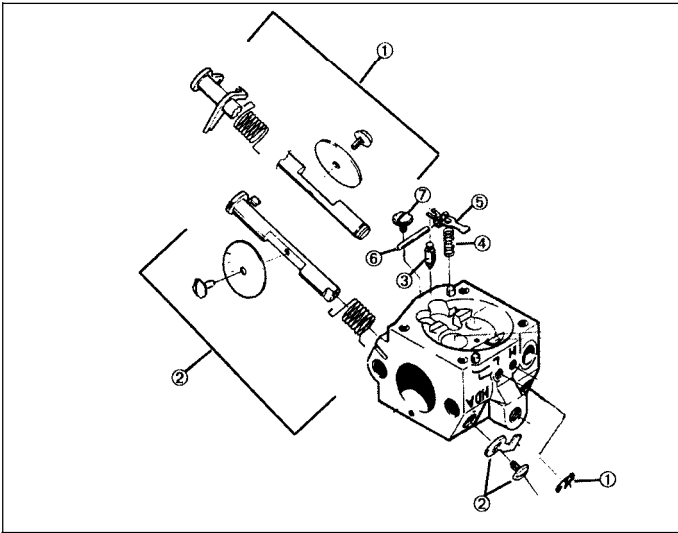

Install choke (1) and throttle (2) assemblies.
Install needle valve (3), spring (4), lever (5) and pin (6). Secure with screw (7).

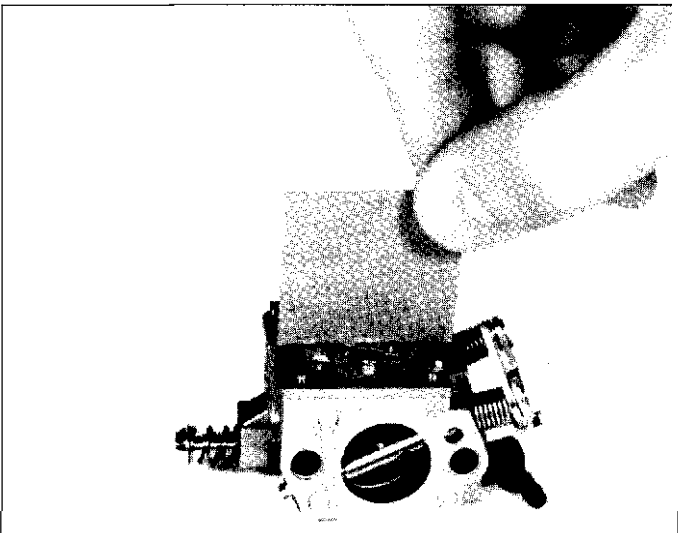

Metering lever must be level with metering diaphragm mounting area of carburetor. Adjust if necessary.

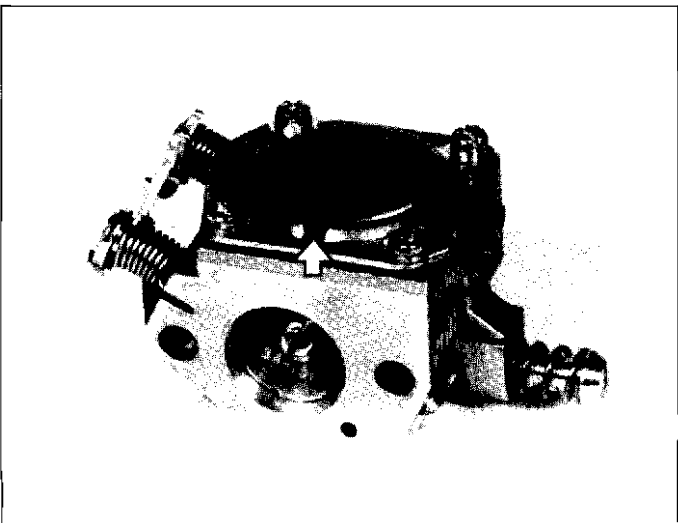

Install metering diaphragm and gasket. (Be sure diaphragm is captured on needle lever.)
Install metering diaphragm cover with ventilation hole facing cylinder. Secure with screws.

Replace fuel inlet screen (1). Assemble fuel pump diaphragm, gasket and cover as shown and secure with screw (2).

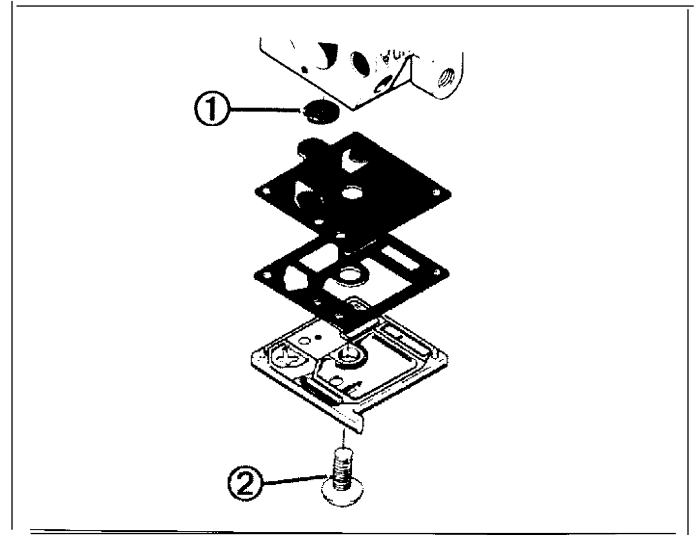

Be sure fuel inlet fitting is angled correctly. Pressure test carburetor as outlined earlier in this section. No leakage is allowed.

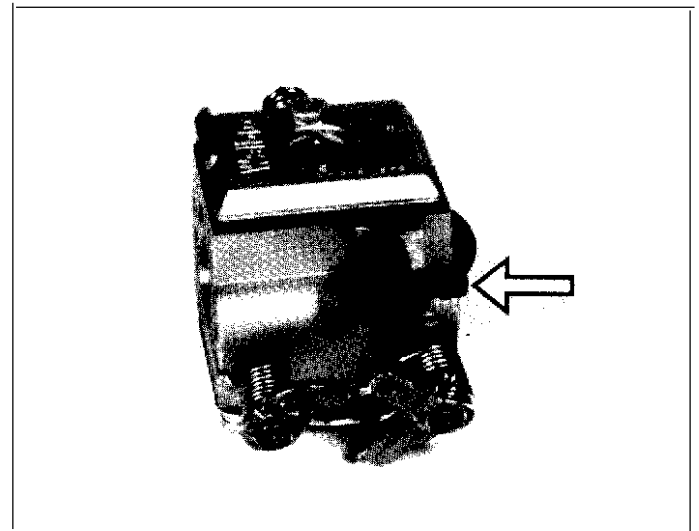

Inspect manifold for damage and make sure impulse channel is open. Replace if necessary.

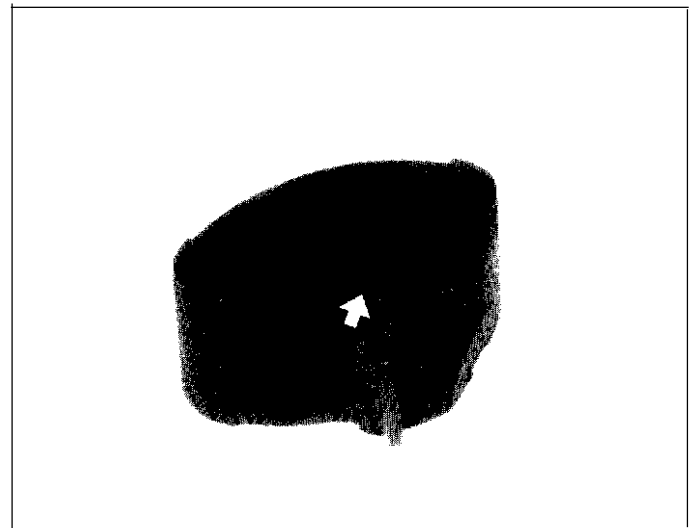

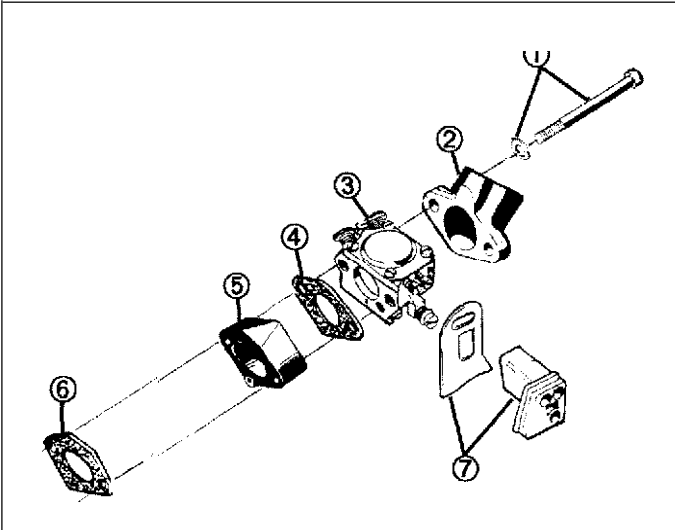

Assemble screws and washers (1), filter holder (2), carburetor (3), gasket (4), manifold (5), gasket (6) and screwdriver guide (7).

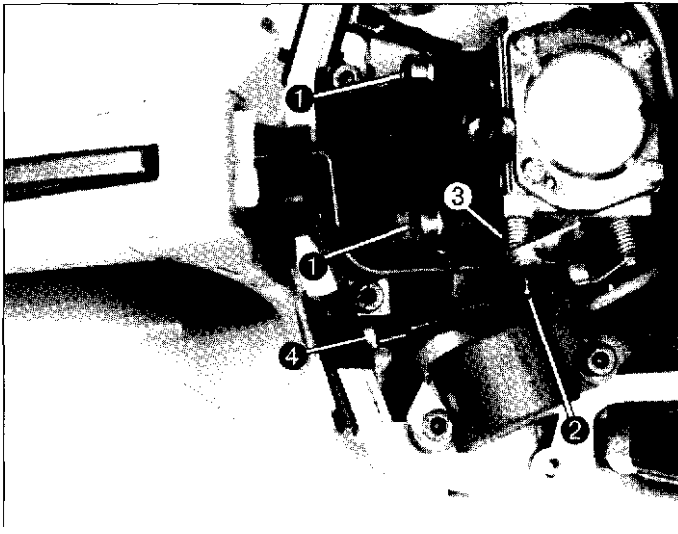

Installation of Carburetor

Connect throttle linkage to carburetor. Position carburetor as shown and tighten screws (1). Be sure fuel hose (2) is at least 95 mm (3-3/4 in.) above fuel tank and connect choke linkage (3) and, as equipped, heat switch lead (4). Install air filter and cylinder cover.

Disassembly

Remove cylinder cover and air filter.

On Model 42D the compression release valve located on the clutch (right) side of the cylinder can be removed for inspection or replaced if necessary by using a 13 mm socket.

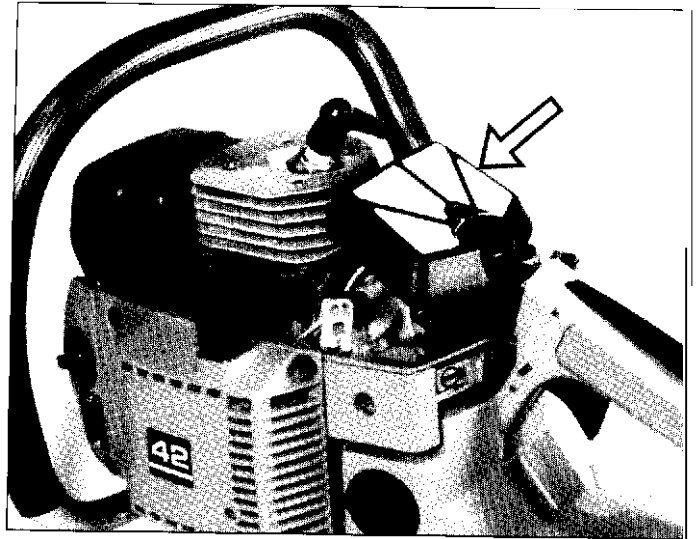

Disconnect choke linkage (1), fuel hose and stop switch wire (2). Remove spark plug lead (3) from spark plug. Remove spark plug.

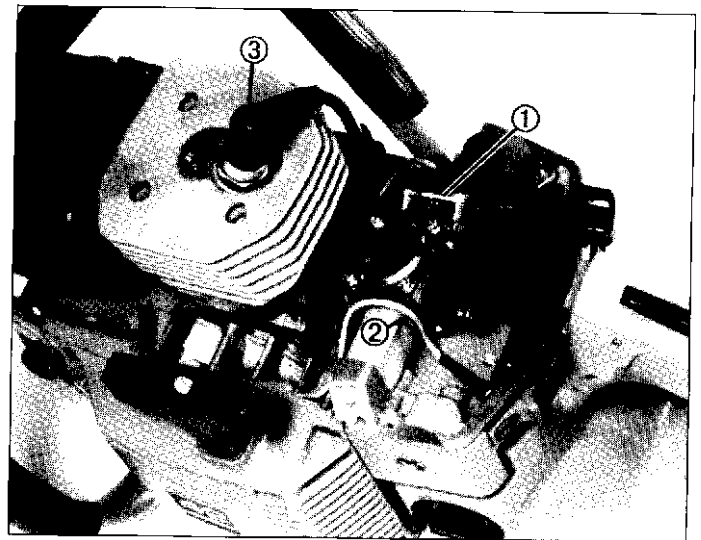

Remove screw securing muffler to front of crankcase. Remove (4) cylinder screws. Lift cylinder assembly, carburetor and muffler from saw.



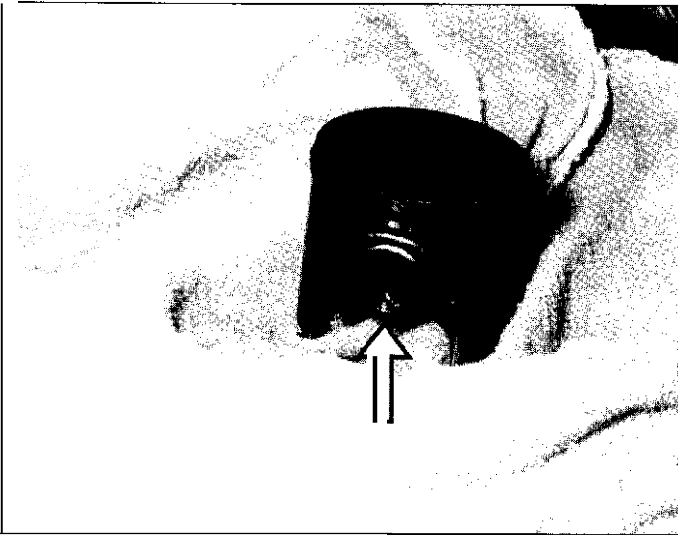

Cover crankcase opening with a clean shop rag. Remove wrist pin circlips. Remove wrist pin. Remove piston and piston ring. Clean carbon from piston top.

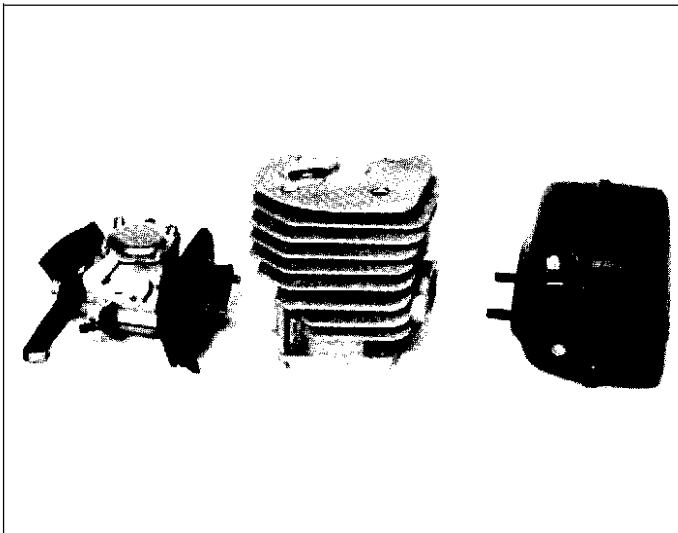

Remove carburetor and muffler. Clean exhaust port. Check spark screen, clean or replace.

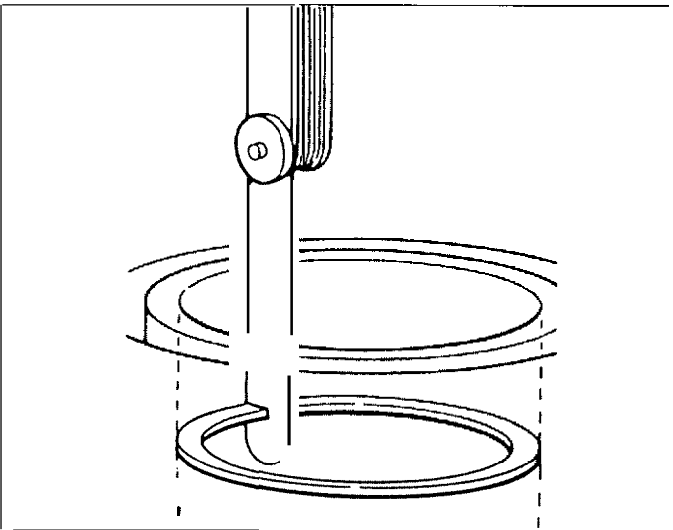

Place piston ring in cylinder approximately 1/2 way down and check ring gap.

NOTE: Proper ring gap is 0.25-0.30 mm (0.010" - 0.012"), max 1.0 mm (0.040).

Assembly

NOTE: Replace all gaskets when reassembling piston/cylinder.

Position piston on connecting rod with arrow on piston top facing the exhaust side as shown. Apply a few drops of oil to wrist pin, Push wrist pin into place. Secure wrist pin with new circlips. Openings in circlips should be at either 12 o'clock or 6 o'clock.

Install new cylinder base gasket.

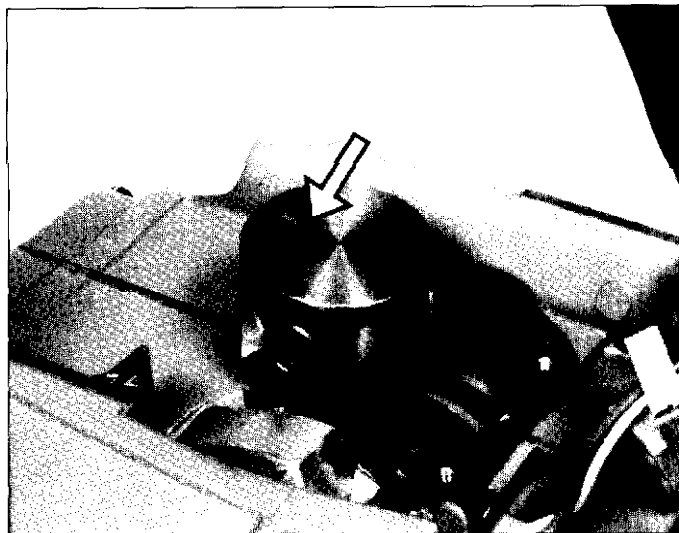

Secure muffler and carburetor to cylinder after replacing gaskets.

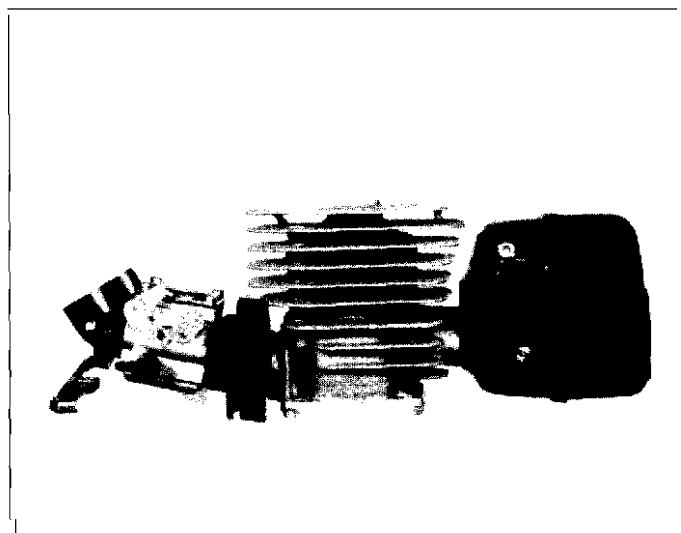

Apply oil to piston. Install piston ring with opening at piston pin. Install piston ring compressor P/N 5025070-01 on piston as shown.





Lower cylinder down onto piston. Gently push cylinder down until ring has entered the cylinder. Remove piston ring compressor.

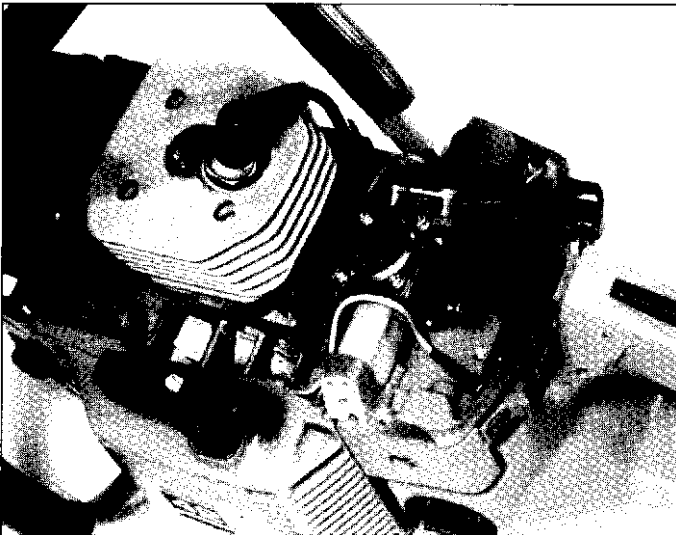

Secure cylinder with screws. (Be sure cylinder gasket is aligned properly before installing cylinder.) Secure muffler support to crankcase with screw. Install spark plug and spark plug lead. Connect choke linkage, fuel hose and stop switch wire.

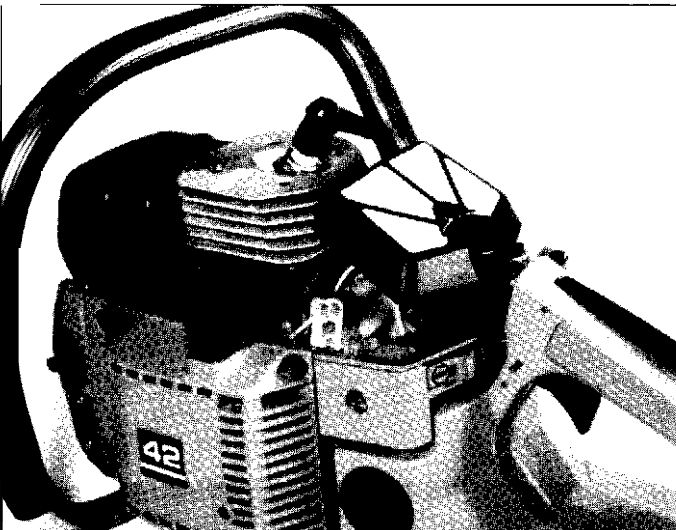

Install air filter and cylinder cover.

Changing a Bar Stud

Empty and rinse out the oil tank. Using a drift punch, tap the bar stud into the oil tank. Extract the stud through the oil filler opening. Insert a smaller diameter wire through the bar stud hole in the crankcase and out the oil filler opening. Wrap the end of the wire around the bar stud threads, then guide the stud through the oil tank and stud hole. Remove the wire. Place a sleeve or washers over the stud. Thread a stud nut down onto the stud to pull the stud into its seat.

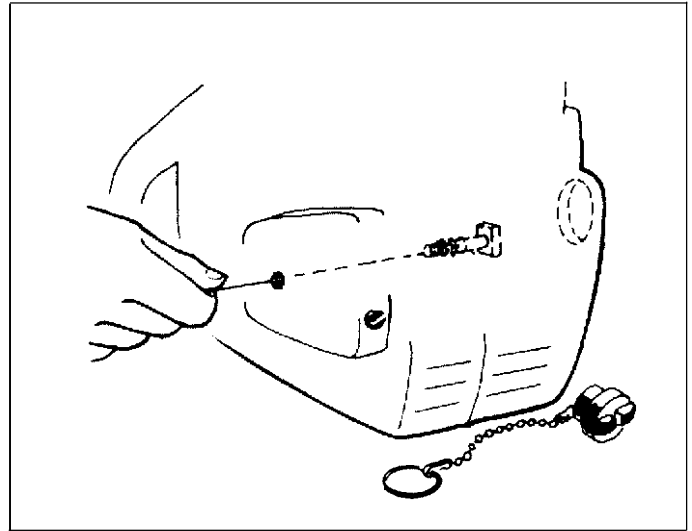

Changing the Crankshaft Seals

The crankshaft seals are accessible after removing:

- The flywheel and, if equipped, the heated handle generator as instructed in Section 6.
- Ignition Systems and the oil pump as instructed in Section 5.
- Chain Lubrication Systems in Section 8.

The seals can be pried out using a suitable screwdriver. Be careful not to scratch or damage the crankshaft during seal removal.

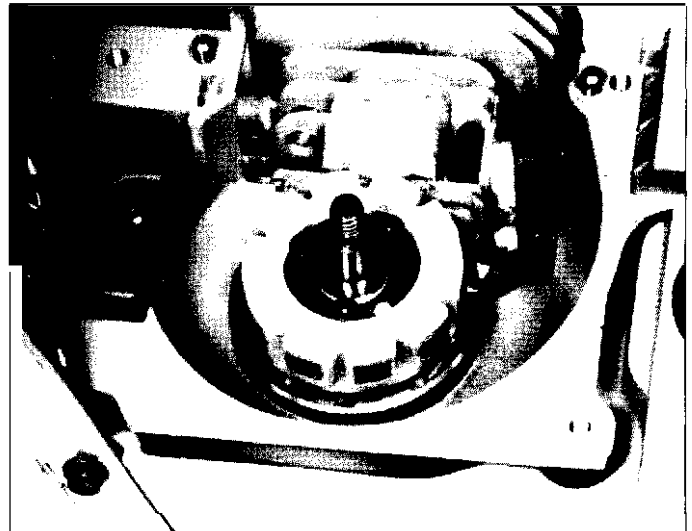

Always use new crankshaft seals for assembly. Begin with the ignition side. Apply grease to the crankshaft seal lip and carefully slide the seal over the end of the crankshaft. The open side of the seal must face inward. Drive the seal into the crankcase using tool P/N 502 50 79-01 until the seal is flush with the crankcase. Install the drive side in the same manner. Reverse disassembly procedure for the remainder of assembly.

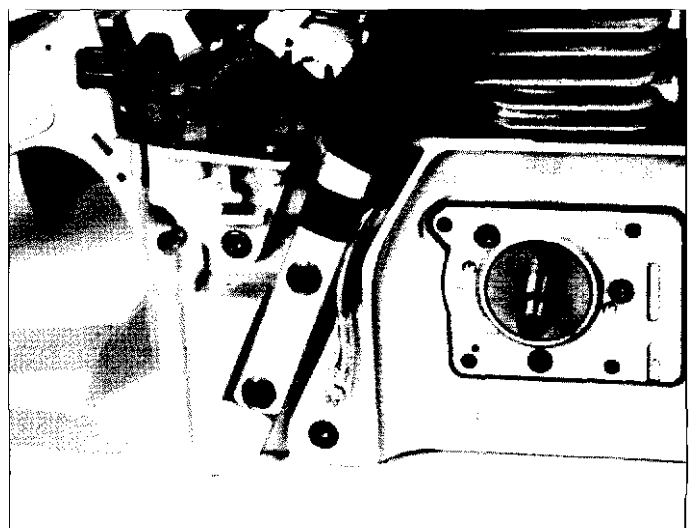

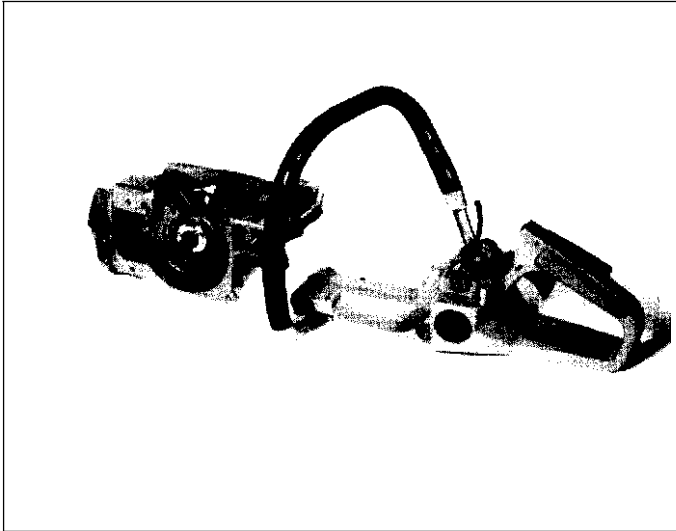

Crankcase

Disassembly

Remove the oil pump (see Section 8), flywheel (see Section 5), piston and cylinder (see Section 11). Remove the four rubber elements and separate the crankcase from the tank.

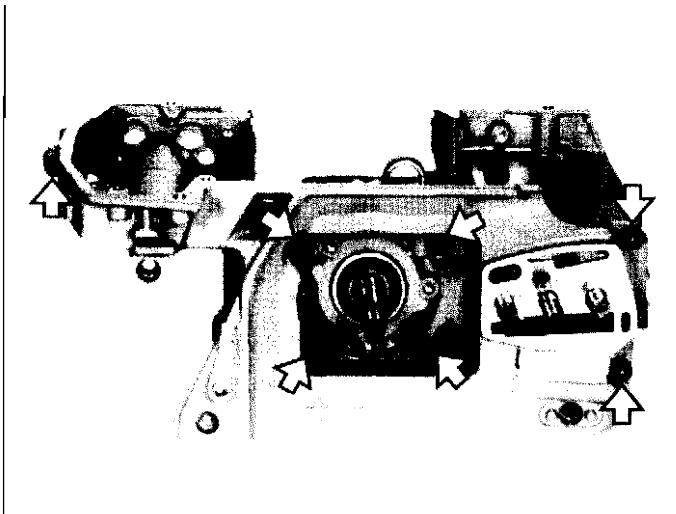

Remove the seven screws retaining the crankcase halves together.

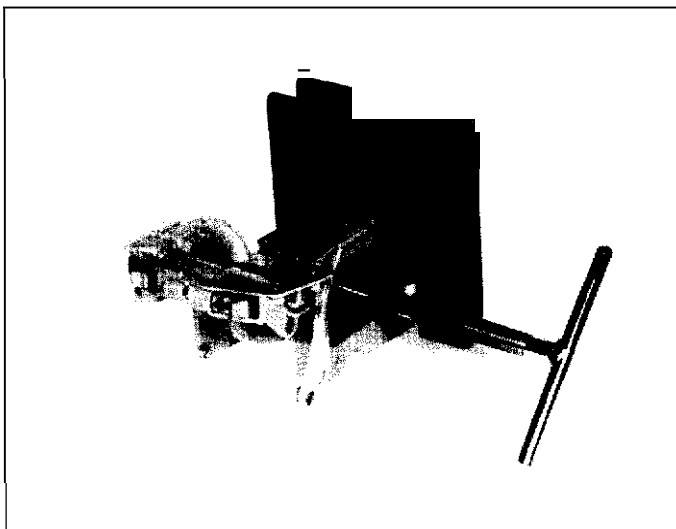

Mount tool P/N 5025161-01 on the clutch side of the crankshaft and crankcase. Separate the crankcase halves by pressing the crankshaft out of the right crankcase half.

Mount the tool on the left crankcase half and press out the crankshaft.

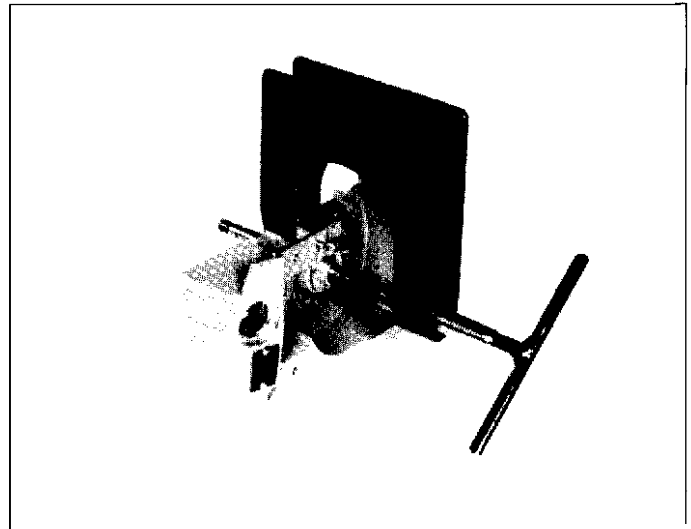

Remove the crankshaft bearings from the crankcase halves by heating up the crankcase around the crankshaft bearing then pressing the bearing out of the case.

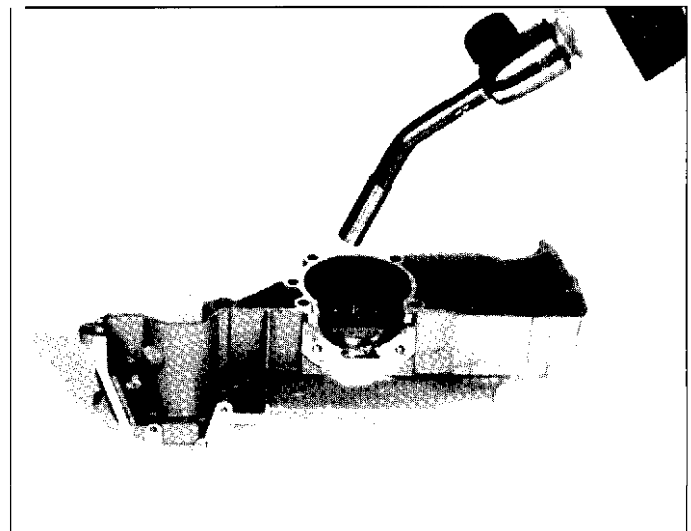

Checking the Crankshaft

The crankshaft is not serviceable and must be exchanged if defective. Some crankshafts may have a slight blue discoloration around the crank pin. This is a normal condition caused by the heat treatment around the crank pin hole during assembly.

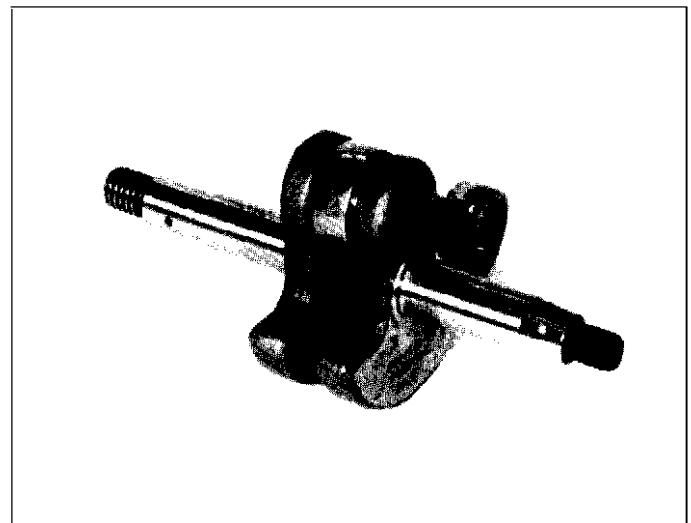

Crankcase and Crankshaft

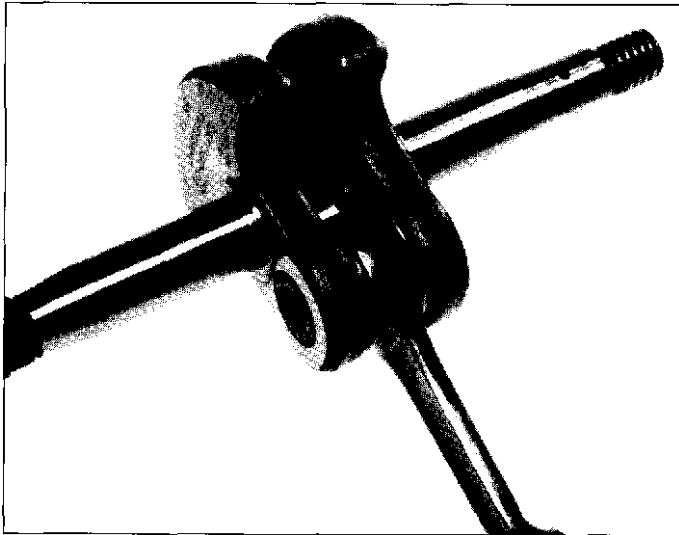

Very carefully inspect the connecting rod big-end (crank pin) bearing. Hold the connecting rod flush against one crank half and then the other while rotating the rod around the pin. Look for cracks or other damage to the bearing cage. Examine the connecting rod big-end for seizure marks on the sides or discoloration.

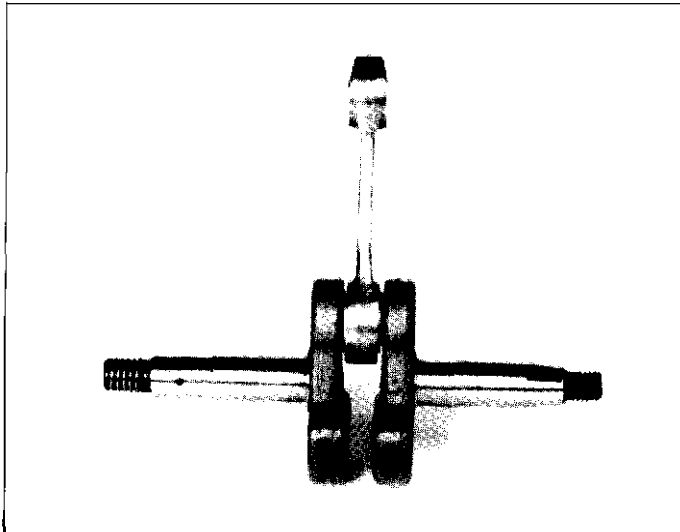

Check for radial movement (up and down play) of the connecting rod. Replace the crankshaft if radial movement is detected. Slight axial movement (side to side) is acceptable.

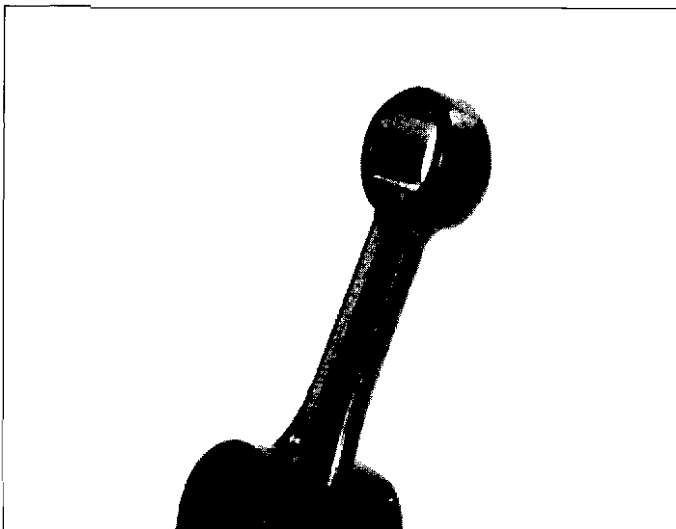

Check the small-end of the connecting rod. If seizure marks or discolored spots are evident in the bearing seat, the crankshaft must be replaced.

Assembly

Thoroughly clean all parts before assembly. Make sure the crankcase half mating surfaces are clean and free of all gasket material. Heat the bearing seat area of the ignition (left) side crankcase half and install the crankshaft bearing. Make sure the bearing is fully seated.

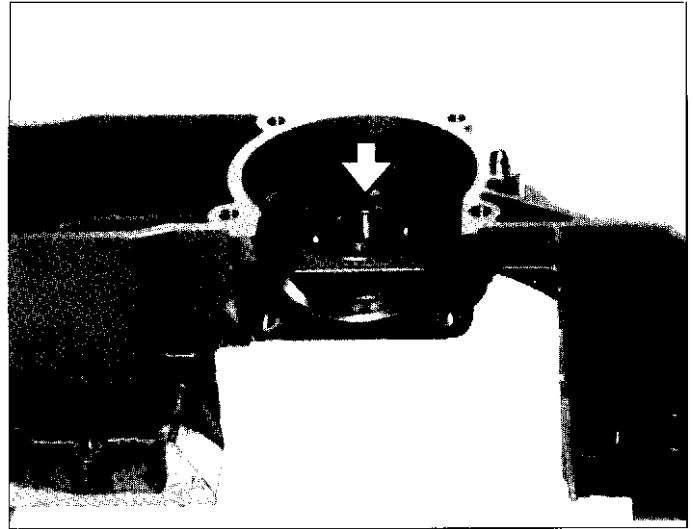

Heat the bearing seat area of the drive (right) side crankcase half and install the crankshaft bearing ensuring it is fully seated.

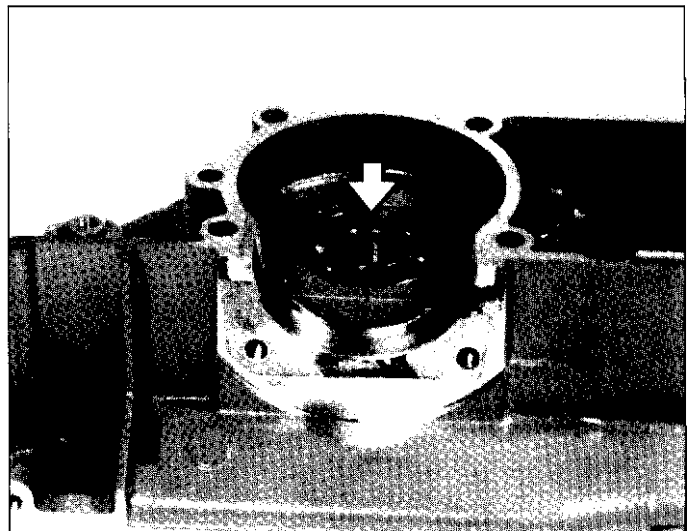

Using assembly tool P/N 5025030-07 pull the crankshaft into the ignition side crankcase half (left). Make sure the crankshaft is flush against the bearing.

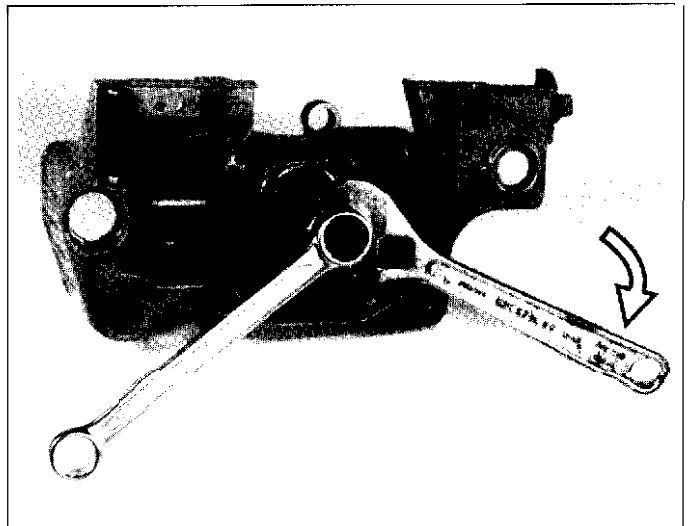

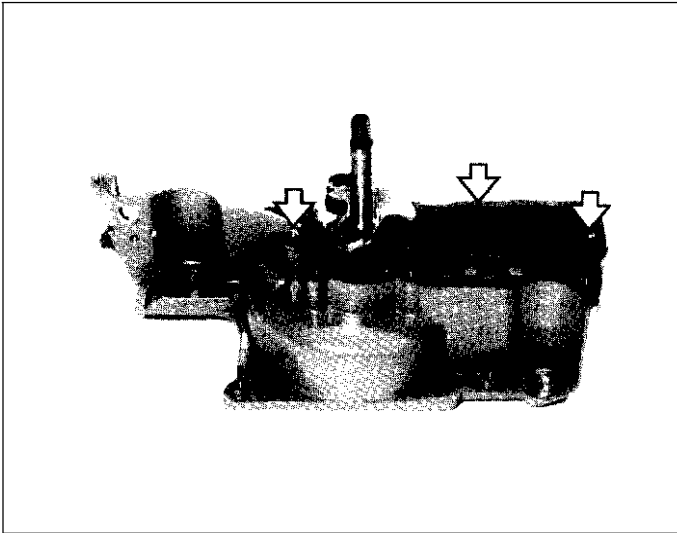

Position the crankcase gasket onto the ignition side crankcase half using a light coating of grease to hold it in place.

NOTE: The crankcase alignment pins should be located in the ignition side crankcase half.

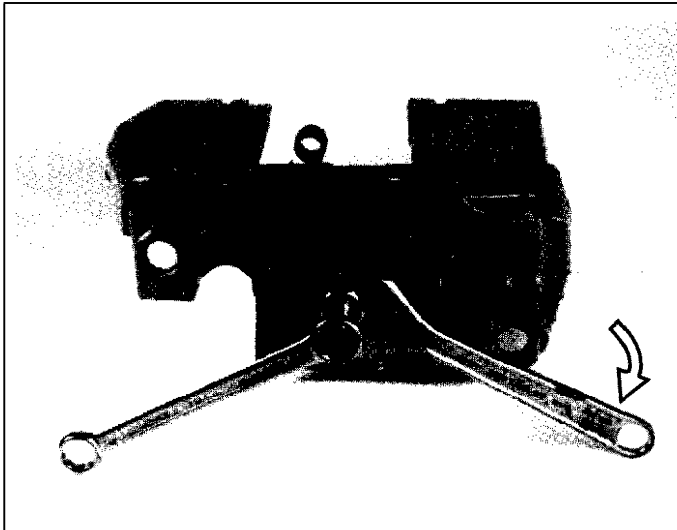

Slide the drive side crankcase half (right) onto the crankshaft, then mount the assembly tool. Pull the crankshaft into the crankcase half while guiding the two halves together. If necessary, start a few crankcase screws to hold the gasket in place. Make sure the crankshaft is flush against the bearing, then remove the assembly tool.

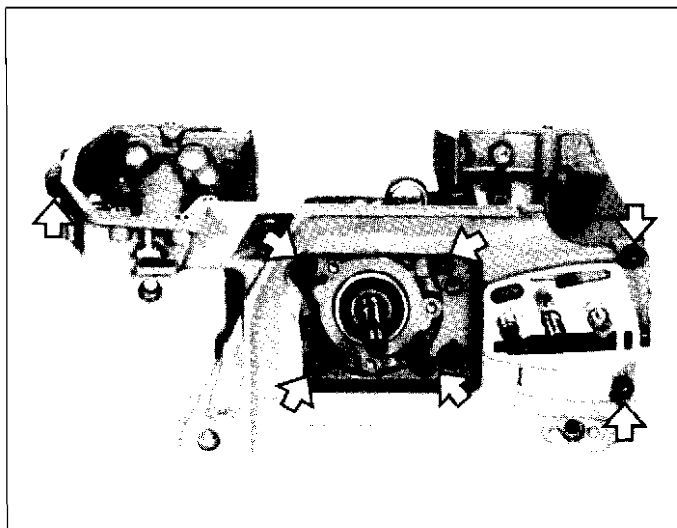

Install all the crankcase screws except the top front screw which also retains the bar spike and muffler support. Starting with the screws around the crankshaft, tighten all six screws to 7-9 Nm (5.1 -6.6 ft. lbs.) torque.

Always use new crankshaft seals. Begin with the ignition side. Apply grease to the crankshaft seal lip and carefully slide the seal over the end of the crankshaft. The open side of the seal must face inward. Drive the seal into the crankcase using tool P/N 5025082-01 until the seal is flush with the crankcase. Install the drive side crankshaft seal in the same manner.

The remainder of reassembly of the unit is the reverse of disassembly. Refer to the appropriate sections for reassembly instructions.

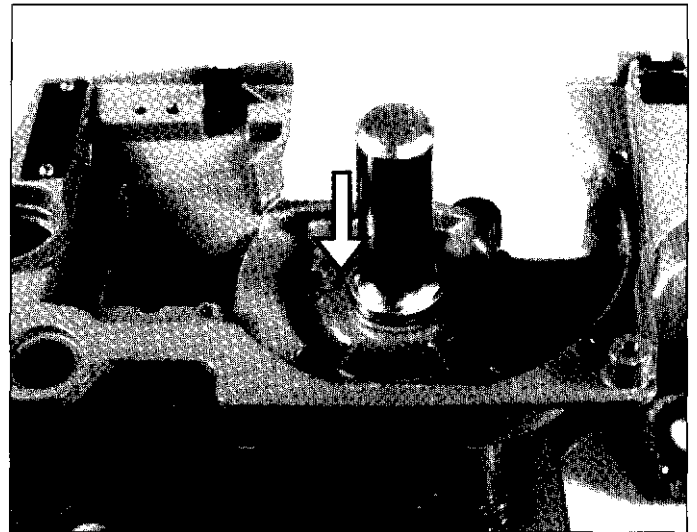

PROBLEM

SOLUTION

	START	Hard starting	Fuel dripping from carburetor	Floods engine when not running	IDLE - LOW SPEED	Will not idle	Rich idle	Idles with needle closed	Erratic idle	"L" needle needs frequent adjustment	Loads up while idling	ACCELERATION, DECELERATION	Will not accelerate	Engine stops when closing throttle	Over-rich acceleration	HIGH SPEED	Will not run at full throttle	Low power	Will not 4 cycle (No rich drop off)
ADJUSTMENTS																			
Low speed needle		•				•	•						•	•	•			•	•
High speed needle													•	•	•			•	•
FUEL SYSTEM																			
Plugged tank vent						•							•				•	•	•
Plugged tank filter		•				•							•				•	•	•
Restricted fuel line		•				•							•				•	•	•
Dirt in fuel passage						•		•	•				•				•	•	•
Loose, damage fuel line			•			•			•				•				•	•	•
Leak in pulse system													•				•	•	•
Restricted pulse channel													•				•	•	•
Loose pump cover screws			•										•				•	•	•
Defective pump diaphragm													•	•	•		•	•	•
AIR SYSTEM																			
Plugged air filter		•											•		•		•	•	•
Defective manifold gasket						•			•				•				•	•	•
Loose carb. mounting bolts						•			•				•				•	•	•
Worn throttle assembly									•										
Incorrect throttle assembly		•				•							•				•	•	•
Loose throttle valve screw									•										
Throttle shaft too tight						•													
Bent throttle linkage						•													
Defective throttle spring						•													
Bent throttle stop lever						•													
Choke not functioning properly		•																	
Worn choke shaft		•																	
Worn choke valve		•																	
Worn throttle valve									•										

(Continued next page)

PROBLEM

(Continued from previous page)

SOLUTION

	START	Hard starting Fuel dripping from carburetor Floods engine when not running	IDLE - LOW SPEED	Will not idle Rich idle Idles with needle closed Erratic idle "L" needle needs frequent adjustment Loads up while idling	ACCELERATION, DECELERATION	Will not accelerate Engine stops when closing throttle Over-rich acceleration	HIGH SPEED	Will not run at full throttle Low power Will not 4 cycle (No rich drop off)
METERING SYSTEM								
Worn lever								
Set too high		•	•	•	•	•		
Set too low				•	•			
Not free				•	•			
Distorted				•	•			
Improperly installed				•	•			
Leaking (air/fuel)		•		•	•			
Worn button				•	•			
Improper assembly				•	•			
Defective gasket		•		•	•			
Loose diaphragm rivet				•	•			
Hole in diaphragm		•		•	•			
Loose cover screws		•		•	•			
Foreign matter		•		•	•			
Binding		•		•	•			
Worn needle body or tip		•		•	•			
CIRCUIT PLATE								
Loose screws, bad gasket				•	•	•		
Nozzle check valve				•	•	•		•

NOTES
